

Hospitality Solution for new & existing hotels

HOTEL ROOM ENERGY SAVING KIT WIRELESS RETROFIT

EXISTING hotel room



GUEST ROOM MANAGEMENT SYSTEM BUS INSTALLATION

NEW hotel room

Hotel

You'll feel right at home

iNELS solution for guest room management is designed to help create an environment that allows guests to feel as if they were at home. The hotel room always welcomes guests with a pleasant temperature and the controls offer a very simple to use option for creating the atmosphere currently wished for.

Every detail contributes to the overall satisfaction rating and the first element, with which the host comes into contact with, is the RFID card reader for entry into the room offered in an attractive glass design. Readers come in a sleek black or white design. To set the desired atmosphere in the room a touch panel is available with a very intuitive user interface for the control of temperature, lighting, shading, or setting the music scenes. Scenes can also be activated automatically upon entering the room. The iNELS solution is the subject of guest comfort, but it also strives for the effective management of all technologies, which significantly contributes to saving energy consumption.



Check In/Out

Thanks to integration into a hotel system, it is possible to create a light scene in the room when a guest registers.



Master Off

When the guest then leaves, the system automatically disconnects all electrical appliances and saves on both heating and cooling costs.



Do Not Disturb

Guests can very easily signal if they want the room cleaned, or do not want to be disturbed.



Comfort

The combination of automatic illumination based on motion and central control of the room.



Design

Through their timeless design, the control unit with display or glass touch unit will complement any interior.



Versatility

The system is suitable for installing in large and small lodging facilities alike.



NEW room – GRMS



Comfort

In a new hotel, smart is not only standard but a necessity. Every detail contributes to the overall satisfaction rating and the first element, with which the host comes into contact with, is the RFID card reader for entry into the room offered in an attractive glass design. Readers come in a sleek black or white design. To set the desired atmosphere in the room a touch panel is available with a very intuitive user interface for the control of temperature, lighting, shading, or setting the music scenes.

- “master OFF” button – one push when leaving room or falling asleep to switch off all lights
- smooth dimming, brightness adjustment as needed, scene settings (sleep, wake-up, work)
- Music & radio with the LARA switch – music/bathroom distribution
- the ability to control and cast music from a smartphone application
- signalling: “Do Not Disturb” and “Make Up Room”



Savings

- fixed temperature limits – min. (for air-conditioning) max. (for heating) – Window opening suspends A/C & heating
- dimming and master off, occupancy sensor
- LED light sources = savings of 30 %
- smart card holder – works only with the correct card – not everyone’s!



Design

- wide range of colours and frames
- glass variants of controllers in different colours
- customization: icons, logo...
- configurable bedside panel as required



Safety

- occupancy sensor detects the presence of person(s)
- integration with the door access system
- the doorbell bell increases the guest’s safety



Flexibility

- possibility to adjust the control functionality
- control and supervision from reception



BUS installation

Control

- standard controllers
- frames from natural materials (wood, glass, metal, stone)
- glass controllers
- touch panel (EHT)
- smartphone application

Audio/Video

- LARA – music & radio player with intercom
- TV control via application (must be used eLAN IR)
- device control via TV (hospitality TV with eLAN RF)

Integration

- GRMS (MUR, DND, Laundry)
- connection with BMS (Building Management System)
- connection with PMS (Property Management System)
- connection with door locks systems

Others

- variability – change controllers place
- navigation for Hotel guests

EXISTING room – RETROFIT

Comfort

Thanks to the wireless communication with devices (sensors and actuators), the retrofit of an existing hotel room can be performed with minimal time consumed. Controllers can be attached anywhere and require no cables at all. The actuators are installed directly into the cabinet or in to the luminaire. The advantage (cost and installation) is that the LED bulb is directly dimmable, i.e. just place it in the main light or lamp. Wireless motion detectors and window openers further extend the possibilities of the entire system.

- “master OFF” button – one push when leaving room or falling asleep to switch off all lights
- smooth dimming, brightness adjustment as needed, scene settings (sleep, wake-up, work)
- Music & radio with the LARA switch – music/bathroom distribution
- the ability to control and cast music from a smartphone application

Savings

- fixed temperature limits – min. (For air-conditioning) max. (For heating) – Window opening suspends A/C & heating
- dimming and master off, occupancy sensor
- LED light sources = 30% saving, plus built-in dimmer inside bulb (2 in 1)

Design

- wide range of colours and frames
- fits to the interior, the controls can be placed anywhere – even bonded to the glass

Safety

- occupancy sensor detects the presence of person(s)
- smoke detector – a fire or smoke from a cigarette
- the doorbell bell increases the guest's safety

Flexibility

- the option to move controls in a variable way – even when not in the place of installation: at the bed, behind the door,...
- the possibility of additional changes or extensions



WIRELESS installation

Control

- standard controllers ●
- frames from natural materials (wood, glass, metal, stone) ●
- glass controllers ●
- touch panel (RF Touch) ●
- smartphone application (eLAN for every room) ●

Audio/Video

- LARA – music & radio player with intercom (LAN cable or Wi-Fi) ●
- TV control via application (must be used eLAN IR) ●
- device control via TV (hospitality TV with eLAN RF) ●

Integration

- GRMS (MUR, DND, Laundry) ●
- connection with BMS (Building Management System) X
- connection with PMS (Property Management System) X
- connection with door locks systems X

Others

- variability – change controllers place ●
- navigation for Hotel guests X

Comprehensive solution

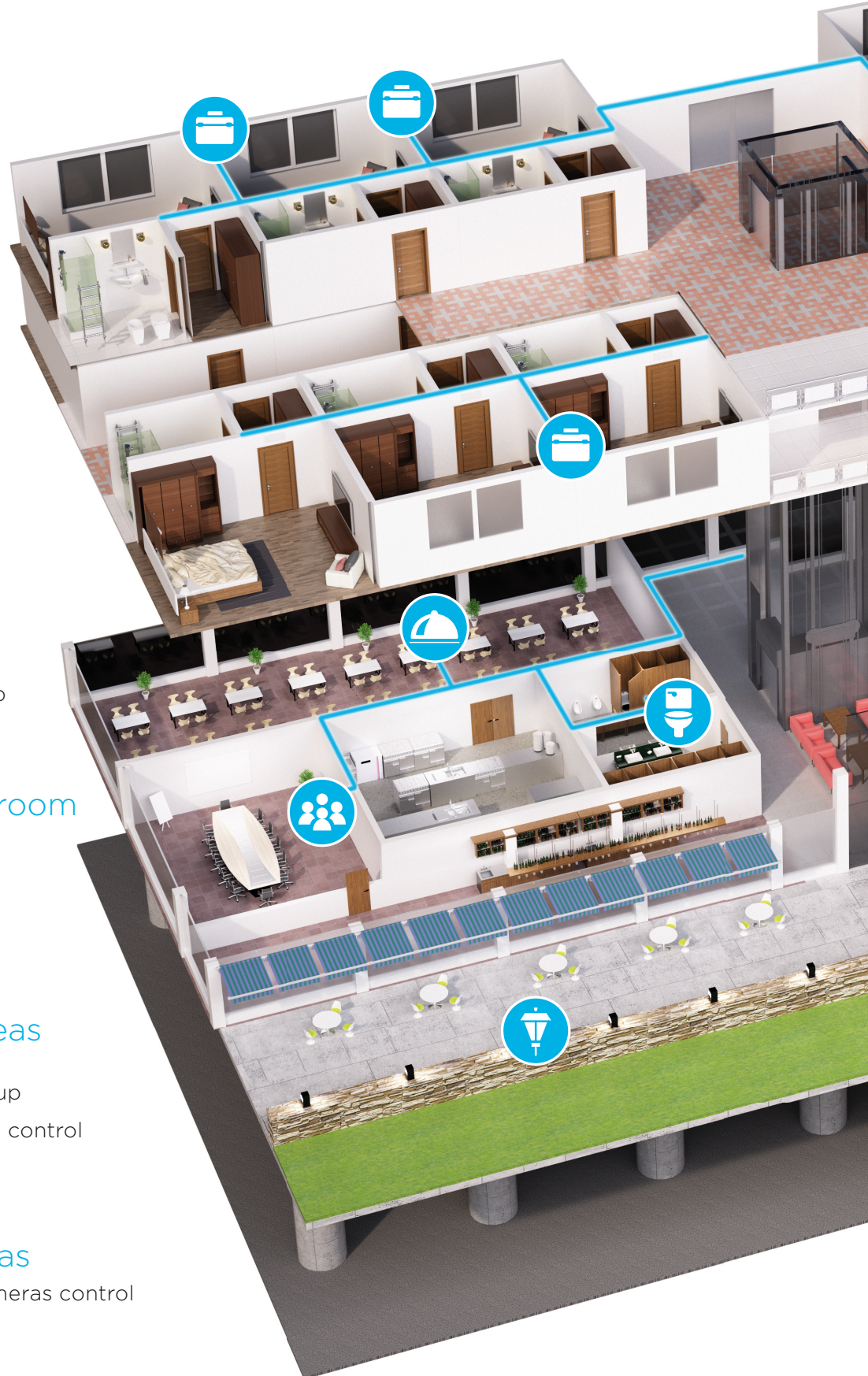

Restaurants & Bars

- Bill transfer
- Ordering via App



Conference room

- Prebooking
- A/V control



Common areas

- Automatic environment setup
- Effective lighting control



Outdoor areas

- Security and cameras control
- Garden watering

BUS/GRMS Solution

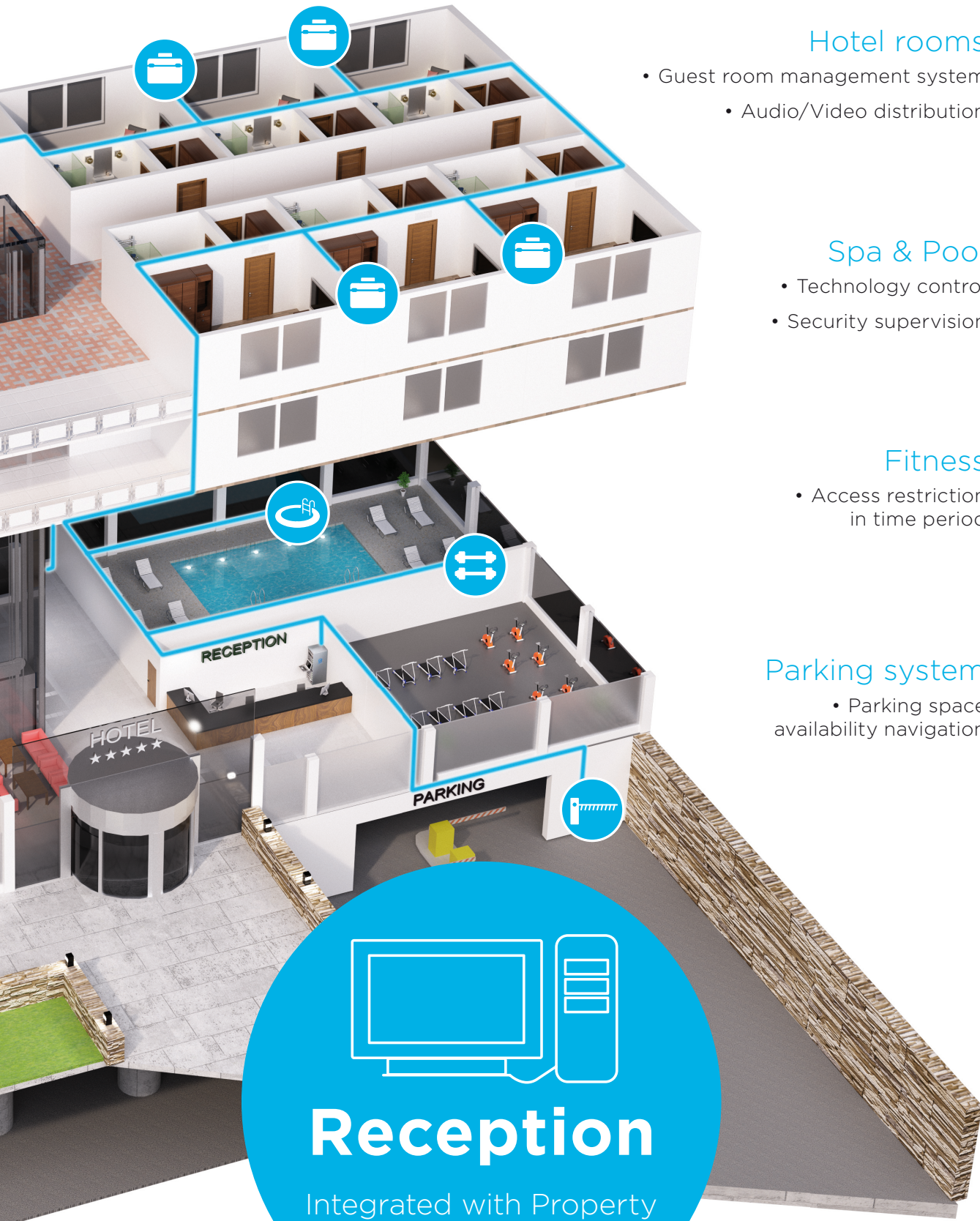

Hotel rooms

- Guest room management system
- Audio/Video distribution



Spa & Pool

- Technology control
- Security supervision



Fitness

- Access restriction in time period

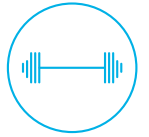

Parking system

- Parking space availability navigation

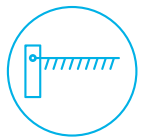

Reception

Integrated with Property Management System



... and other Property Management System softwares via API

NEW room

iNELS solution for guest room management is designed to help to create an environment that allows guests to feel as if they were at home. The hotel room always welcomes guests with a pleasant temperature and the controls offer a very simple to use option for creating the atmosphere which was currently wished for.



Elko Hotel Touch Screen

Fully configurable 3.5" touch screen with TFT display in variety frames design. Allows the control of all iNELS Hospitality features including multimedia. Configurable allowing of making of personalised screens for control lights, shutters, HVAC, audio, video and TV.

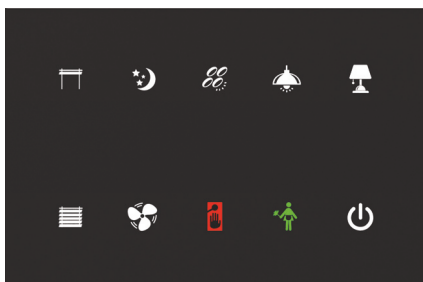

Glass Switch Panel

Luxury glass touch control in four versions with 2, 4, 6 and 10 buttons in various backlight colours is available in elegant glass design. Switches also sense the ambient lighting and offer a choice of symbols.

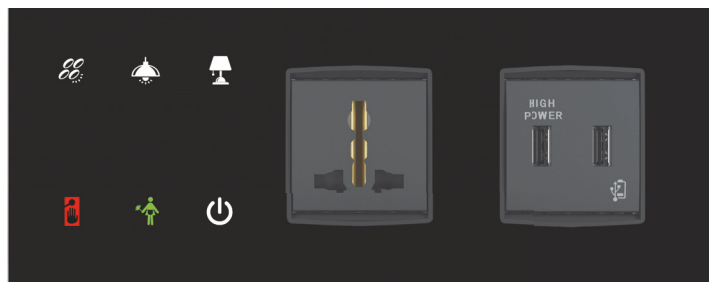

Glass Bedside Panel

Important buttons for light, TV scenes, master switch and sockets, other sockets for equipment are available.



Configure bedside panel (see page 35)

BUS/GRMS Solution

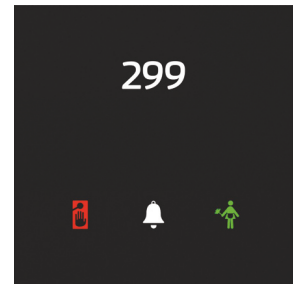
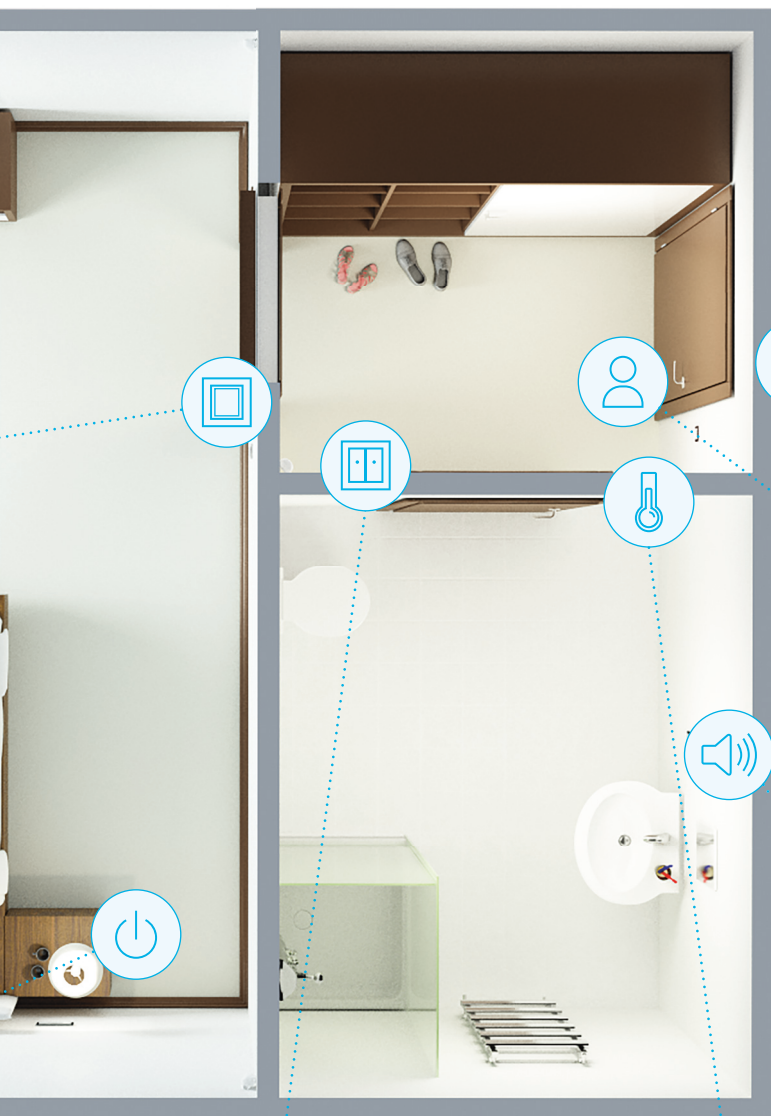

Glass Card Reader

The RFID card reader is a great design for the entrance to the rooms which also features a bell signal the "Do Not Disturb" and "Make Up Room" signs and backlit room number.



Glass Card Holder

In-room smart card holder with RFID reader which detects correct card and eliminates fake cards.



Wall Switch Button

For scene control (lighting, music, and projection) it is also possible to use flat wireless switches, which thanks to customizable printing offers clear control.

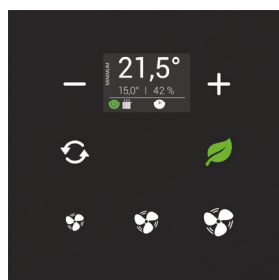

Glass Room Thermo-regulator

Temperature glass controller for simple temperature setup. Fan and mode control. OLED display with actual and setup temperature value.

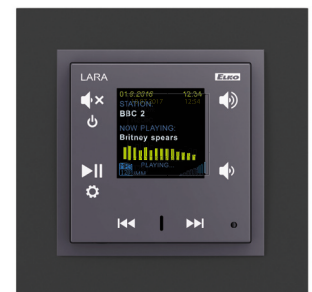

Audio Player

Provides many thousands of Internet radio channels from all over the world or share music from central storage. Integrated amplifier can feed compact loudspeakers, external ceiling or wall speakers.



Elko Hotel Touch Screen

Control whole room from one place

Fully configurable 3.5" touch screen with TFT display in variety frames design. Allows the control of all iNELS Hospitality features including multimedia. Fully configurable allowing the making of personalised screens for control lights, shutters, HVAC and audio.

Make up rooms, do not disturb and laundry buttons included. Variable choice from the many frame designs and subframes under LOGUS⁹⁰ design (see page 37).



Elko Hotel Touch Screen

EHT3

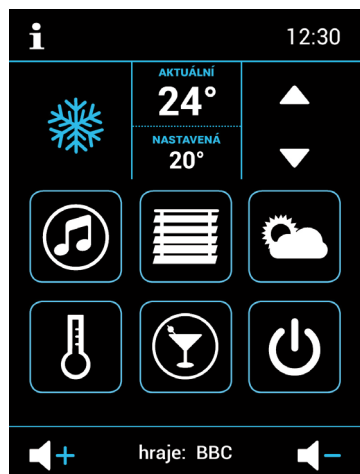

HVAC Control

Actual/Setup temperature, Temperature up/down, fan speed.

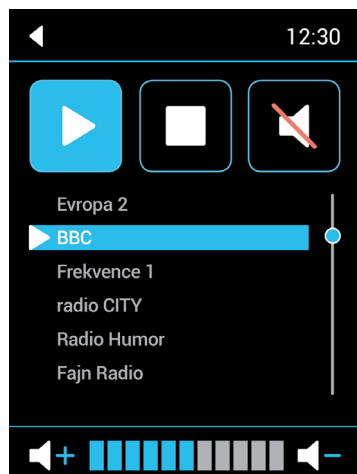

Multimedia

Radio and TV station, Music from storage or own source.

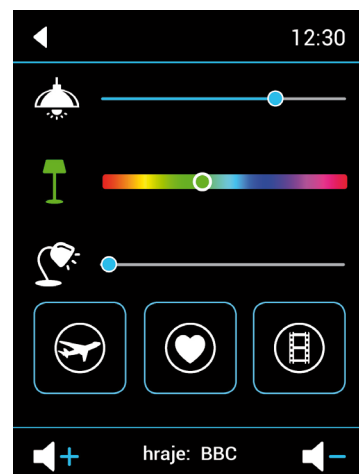

Light/Scenes

Lights ON/OFF, dimm, scenes, Master off.



Bedside Panel

Not reason to rise from bed

Wide possibility of customization. Allowing the creation of bedside panels on request. Important buttons for light, TV scenes, master switch and sockets, other sockets for equipment are available.

Glass finish with more colours (including smoke and white), and international sockets as options.

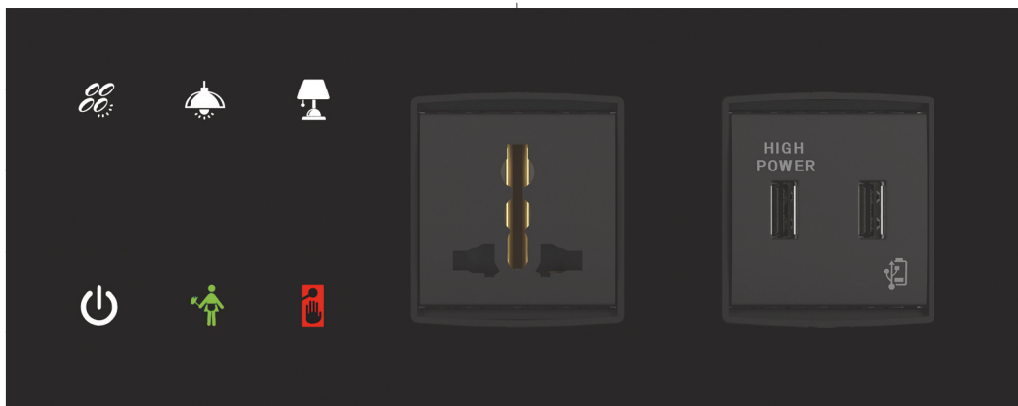

6 buttons with indicator

AC power socket

2x USB sockets

For more options & configuration see **page 34-35**

Control Panels

Wider range of room controllers in variable designs

Fully customisable controllers. Finished frames in glass or plastic. 2, 4, 6, 8 and 10 buttons version available. Symbols and logo engraving by laser.

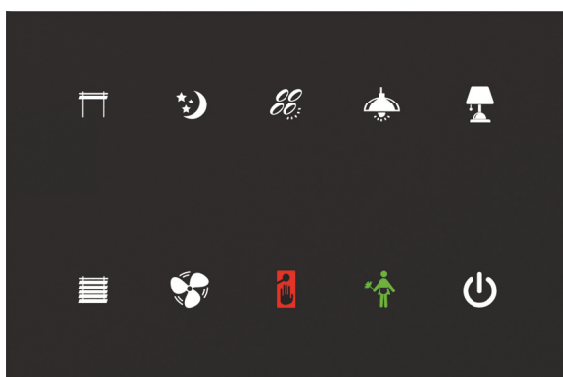
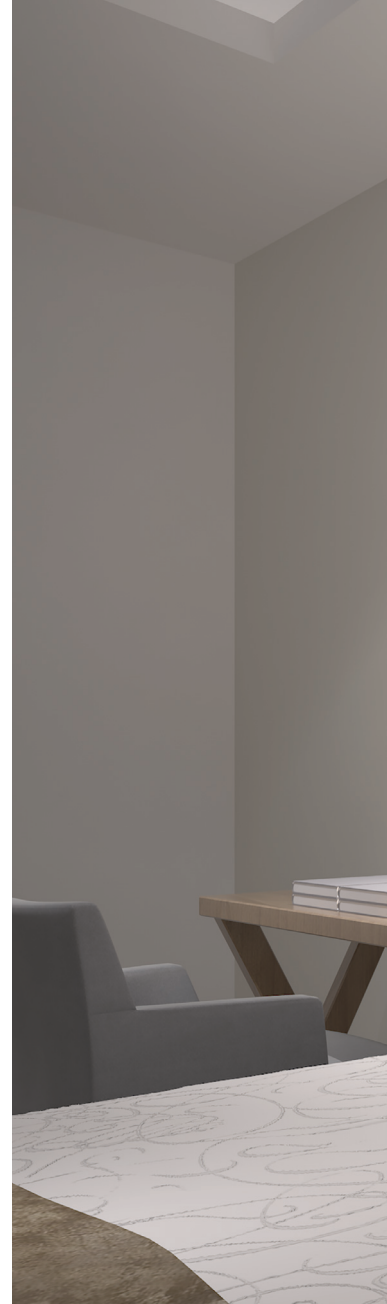

Glass Switch Panel

GSP3-100/B

Luxury glass touch control with 10 buttons is available in elegant black and white. Switches also sense the ambient lighting and offer a choice of symbols.

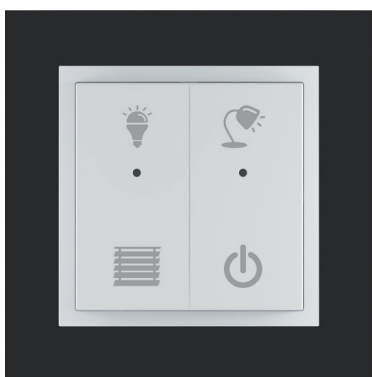

Wall Switch Button

WSB3-20 / WSB3-40

For scene control (lighting, music, and projection) it is also possible to use flat wireless switches, which thanks to customizable printing offers clear control.

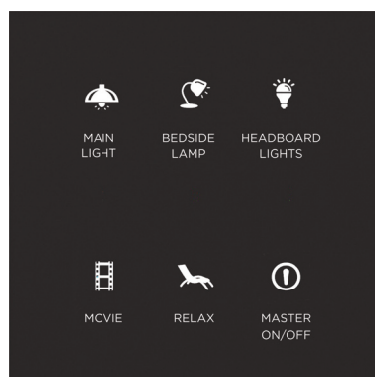

Glass Switch Button
(with symbols)

GSB3-60/SB

Customizable touch control solution for lighting control and other technologies in different scenarios e.g. reading books, relaxing, watching TV, Master Off.

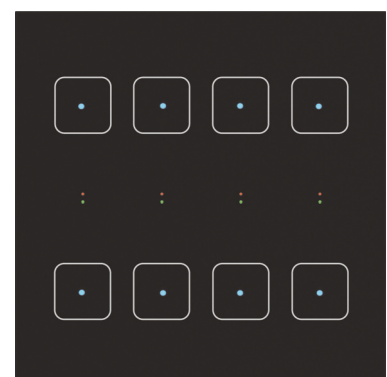

Glass Switch Button

GSB3-80/B

Luxury glass touch control in three versions with four, six or eight buttons are available in elegant black and white. Switches also sense the ambient lighting.



Heating, ventilation & air-conditioning

Keep yourself comfortable

With iNELS you have always more possibilities how to setup and control temperature in the room: digital thermostat, glass HVAC controller, App in smartphone, table or via TV,

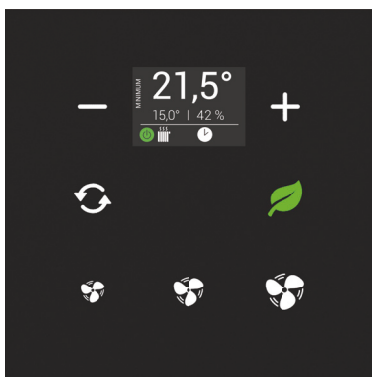

Glass Room Thermo-regulator

GRT3-50/B

Temperature glass controller for simple temperature setup. Fan and mode control. OLED display with actual and setup temperature value.

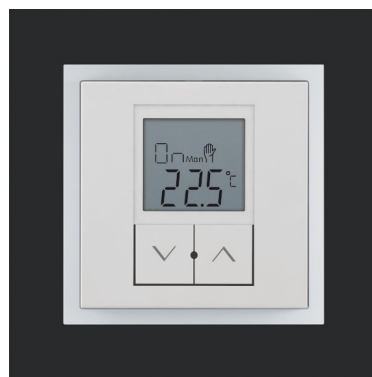

Digital Room Thermoregulator

IDRT3-1

Digital wall temperature controller used to regulate the temperature in a room. Using the IDRT3-1, it is possible to correct the given heating/cooling circuit within a range of ± 3 , ± 4 or ± 5 °C.

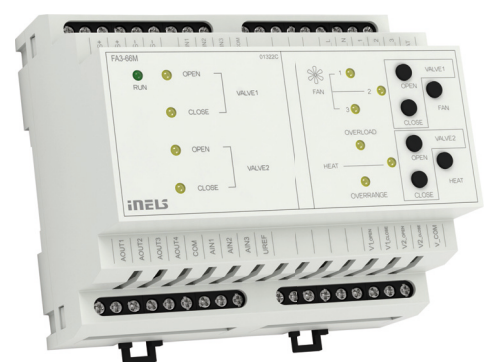

Fan Coil Control Actuator

FA3-612M

Actuator is used to control fancoil's units via an analog/digital inputs. Analog inputs are for temperature measurement, voltage or current. Connection is to installation BUS.



Bathroom Music & Power Kit



DLNA

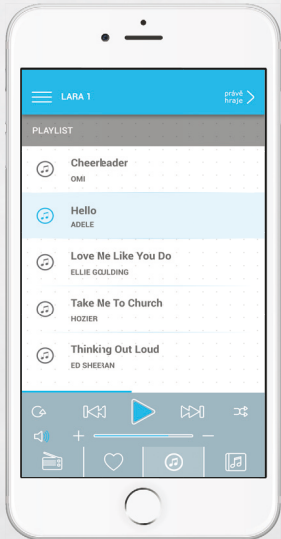

App LARA Dio



Wireless RFIO²

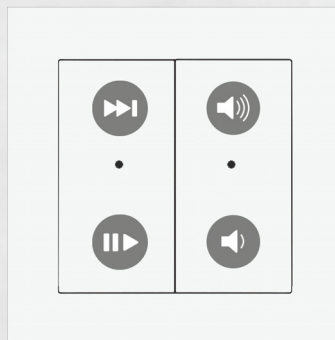

Additional Control Button



Audio distribution

Music in all corners

iNELS option allows you to share radio and music in the bathroom as well as the main room. Source of songs in central NAS Server or your own device - via cable or Wi-Fi.



Radio & Music player

LARA

Provides thousands of Internet radio channels from all over the World or share music from central storage. Integrated amplifier can feed compact loudspeakers or external ceiling or wall speakers.

More info on lara.inels.com

Room control via TV

Everything you need in your hotel TV

TV programs, movies on demand, temperature level, lighting control, hotel bill, hotel activity offers - all these and more features can be controlled by you via hotel room TV.



Lights



Temperature control



Music



TV



Movie on demand



Hospitality TV App

You can make your own song playlists, play radios or favorite movies. Via TV menu it is possible to control audiozones and the LARA music player.

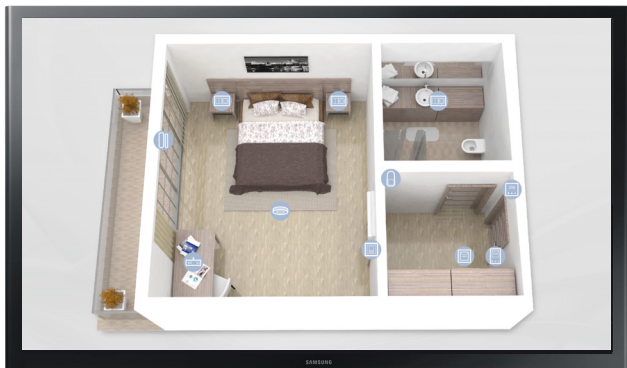

Room Control

Hotel managers can easily manage and arrange the channel mix for both analogue and digital channels without the need to adjust and edit channel lists by different TV systems. Channels can be reordered and renamed to the hotel's preference with channel mapping.



My Channel/Multimedia

Enable guests to easily find and enjoy the programming of their choice without having to manually scroll through hundreds of TV channels. My Channel's quick search function allows guests to find channels suited to their tastes, by country and genre.



Access control

Clever access under top security

iNELS Hospitality offer two ways for access to room and other hotel facilities.

First option is our own door entrance panel with in built card reader, bell button, make up room and don't disturb indicators. Room number can be placed as well.

Second option is integrated VingCard (Assa Abloy) lockers which communicate wirelessly with hub and afterwards with iNELS Connection Server. This solution also provides information about locker activity to iNELS.



Integration with locker

IP integration



BUS integration



iNELS Digital Key

This smartphone app with a digital key (IDK) is another smart way how to unlock your room if you don't have a card with you.



Glass Card Reader

GCR3-11/B, RFGCR-31/B

The RFID card reader is a great design for the entrance to the rooms which also features a bell signal the "Do Not Disturb" and "Make Up Room" signs and backlit room number. Thanks to the integrated relay it can control the door lock directly.



Glass Card Holder

GCH3-31/B, RFGCH-31/B

In-room smart card holder with RFID reader which detects correct card and eliminates fake cards. Optional 3 buttons: "Do Not Disturb", "Make Up Room" and "Master Off". When card is inserted lights on the side changes from red to green.



Common areas

Total supervision for reliable service

iNELS enables management and control of each luminaire whether with your own the BUS, DALI or DMX.

Lamps can be controlled by time, human presence, the intensity of outdoor (natural) light or only as needed (areas) - all these control methods can be combined together. For monitoring you can use a camera system, iMM is possible to integrate resources for heating, air conditioning and recovery. iNELS also allows the measurement of energy, including monitoring of critical values and periodic reports.



Overview of the app

Receptionists will appreciate the fast control and supervision via tablet or touch panel. More common areas should be visualized on multiple screens.

Product overview

Glass Touch Controllers

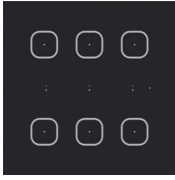

Glass Switch Button

GSB3-20
GSB3-40
GSB3-60

- Glass touch controllers without symbols
- All versions are in the size of the module (94x94 mm)
- vibration touch feedback
- acoustic touch feedback
- glass colour: white or black

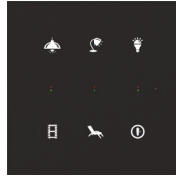

Glass Switch Button (with symbols)

GSB3-20/S
GSB3-40/S
GSB3-60/S

- Glass touch controllers with individual symbols
- All versions are in the size of the module (94x94 mm)
- Individual symbols can be illuminated in one of several colours
- glass colour: white (W) or black (B)

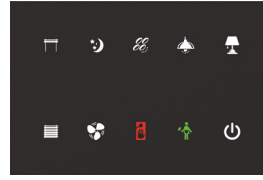

Glass Switch Panel

GSP3-100/B (black glass)
GSP3-100/W (white glass)

- Glass Touch Panel GSP3-100 is part of a comprehensive iNELS series of units for the management of the hotel rooms and other areas
- ten touch buttons

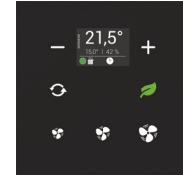

Glass Room Thermo-regulator

GRT3-50/B
GRT3-50/W

- display for showing the current room temperature
- GRT3-50 is also suitable for controlling fan-coils
- Thermo-regulator is equipped with an integrated temperature sensor

Access Control

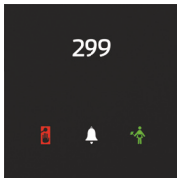

Glass Card Reader

GCR3-11/B
GCR3-11/W

- The RFID card reader is a great design for the entrance to the rooms which also features a bell signal the "Do Not Disturb" and "Make Up Room" signs.
- protocol: NFC

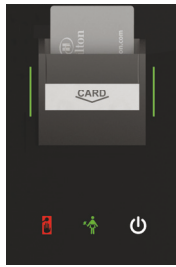

Glass Card Holder

GCH3-31/B
GCH3-31/W

- In-room card holder with RFID reader which detects correct card and eliminates fake cards. Optional 3 buttons: "Do Not Disturb", "Make Up Room" and "Master Off".

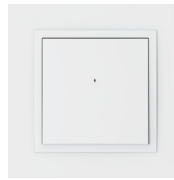

Wall Card Reader

WMR3-21

- RFID card reader 13.56 MHz
- NFC ready
- 2 push-buttons, LOGUS⁹⁰ design
- rated current 50 mA from BUS



Card Switch

90731 TBR

- After inserting hotel card to card switches it will activate automatic regulation of the lights in the room.

Audio

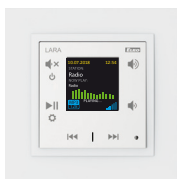

Music Player

LARA Radio

- plays the stream of internet radios and music from NAS or external source or DLNA
- equipped with an internal amplifier 2x 10 W

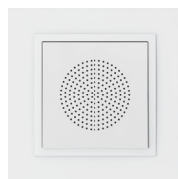

LOGUS Speaker

Into a frame

- dimensions (mm): ø 50.8
- maximum output: 10 W
- impedance: 32 Ω
- design LOGUS⁹⁰



Ceiling Speaker

Into a suspended ceiling

- dimensions (mm): ø 127
- maximum output: 30 W
- impedance: 8 Ω
- colour: white

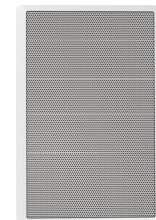

Wall Speaker

On the wall

- dimensions (mm): 270 x 183 x 37
- maximum output: 15 W
- impedance: 8 Ω
- colour: white



Glass Bedside Panel 1 fold

GBP3-60/BR/1F

- GBP3-60 panel is equipped with six customizable touch buttons
- control units for guest room management system

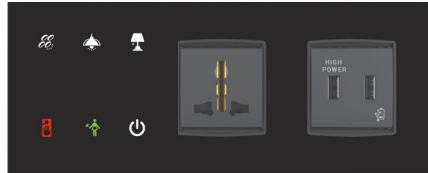

Glass Bedside Panel 2 fold

GBP3-60/BR/2F
GBP3-60/WL/2F

- GBP3-60 panel is equipped with six customizable touch buttons
- control units for guest room management system



Elko Hotel Touch Screen

EHT3

- touch screen panel with 3.5" display
- controls temperature, lighting, shading, scenes
- LOGUS⁹⁰ design
- rated current 150 mA from BUS
- configurable screen from IOM

Standard (plastic) Controllers



Wall Switch Button

WSB3-20

- 2 push-buttons, design LOGUS⁹⁰
- integrated temperature sensor
- one colour signalization LEDs
- rated current 25 mA from BUS



Wall Switch Button

WSB3-40

- 4 push-buttons, design LOGUS⁹⁰
- integrated temperature sensor
- two colours signalization LEDs
- rated current 25 mA from BUS



Digital Room Thermo-regulator

IDRT3-1

- digital thermo-regulator
- measures and controls temperature in room
- rated current 20 mA from BUS
- design LOGUS⁹⁰



Bedside Panel

WSB3-40, Schuko,
2x USB supply unit

- design LOGUS⁹⁰
- configure according to your request

Detectors



Combined Detector

DMD3-1

- power: 27 V DC
- combined detector
- detect: motion and luminescence
- temperature and humidity sensor



Motion Detector

RFMD-100

- connected to RF
- detection angle 105°
- shot length 12 m (13.12 yd)
- wireless RFIO²
- detect: motion

Product overview

System Units



Central Unit

CU3-03M

- basic element of the system
- 1x BUS, 1x EBM BUS
- 3x ethernet 100 Mbps
- 8x DIN GS
- 4x DIN
- 7x AIN

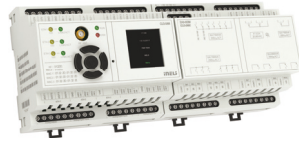

Guest Room Bundle

CU3-04M
(CU3-03M & EA3-022M)

- manages DND/MUR, lighting, HVAC and shading in the guest room
- communicates with the BMS and PMS
- EA3-022M: not sold separately



External Master BUS

MI3-02M | MI3-02M/EHT

- allows to expand the system 2x BUS
- communicates with the central unit via EBM (MI3-02M) or via Ethernet (MI3-02M/EHT)



BUS separator from power supply

BPS3-01M | BPS3-02M
1x BUS 2xBUS

- supply voltage: 27 V DC
- indication of output voltage outputs BUS LED

Switching Actuators



Switching actuator, 2-channel

SA3-02M

- 2x changeover contacts 16 A/AC1
- switching voltage 250 V AC1, 24 V DC
- controls sockets, shutters, lights, appliances etc.
- rated current 50 mA from BUS



Switching actuator, 4-channel

SA3-04M

- 4x changeover contacts 16 A/AC1
- switching voltage 250 V AC1, 24 V DC
- controls sockets, shutters, lights, appliances etc.
- rated current 70 mA from BUS



Switching actuator, 6-channel

SA3-06M

- 6x changeover contacts 8 A/AC1
- switching voltage 250 V AC1, 24 V DC
- controls thermostats, lights, appliances etc.
- rated current 60 mA from BUS



Switching actuator, 12-channel

SA3-0

- 12x NO contacts 8 A/AC1
- switching voltage 250 V AC1, 30 V DC
- controls thermostats, lights, appliances etc.
- rated current 20 mA/230 V AC

Dimming Actuators



Universal dimming actuator, 2-channel

DA3-22

- 2-channel universal dimming actuator
- load type: LED, ESL, resistive, inductive, capacitive
- maximum load: 400 VA for each channel
- rated current 10 mA from BUS



Dimming actuator for electronic ballasts, 2-channel

LBC3-02M

- two-channel actuator for fluorescent lamps
- analog outputs automatically control relays
- 2x 0(1)–10 V, 2x changeover contacts 16 A/AC1
- rated current 60 mA from BUS



Dimming actuator for LED sources, 3-channel

DCDA-33M

- three-channel actuator for LED controlled by variable current
- dimming load 12–24 V DC
- controlled via BUS, DALI or DMX
- rated current 350 mA from BUS



Dimming actuator, 6-channel

DA3-06M

- 6-channel universal dimming actuator
- load type: LED, ESL, resistive, inductive, capacitive
- maximum load: 150 VA for each channel
- rated current 10 mA from BUS

HVAC Control

Shutter Actuators



Fan-Coil Control Actuator
FA3-612M

- analog outputs 0–10 V
- connection to BUS
- analog inputs for temperature, voltage or current measurement (Uref reference voltage can also be used)



Shutter Actuator,
18-channel

JA3-018M

- 9-channel shutter actuator
- controls shutters, blinds, awnings etc.
- switched voltage 250V AC
- maximum load 4 A/AC 15 for each channel
- rated current 60 mA from BUS



Shutter actuator,
2-channel

JA3-02B/DC

- controls shutters, blinds, awnings etc.
- switched voltage 12–24 V DC
- maximum load 0,85 A
- rated current 60 mA from BUS



Switching actuator,
22-channel

SA3-022M

- 12x NO contacts 6 A /AC1
- 4x NO contacts 10 A/AC1
- 4x SSR contactless 0,5 A/AC1
- equipped with 22 relay outputs
- switching lighting and socket circuits



Switching actuator,
1-channel

SA3-01B

- 1x NO contact 16 A/AC1
- switching voltage 250 V AC1, 24 V DC
- controls sockets, thermos valves, lights, appliances etc.
- rated current 30 mA from BUS



Switching actuator,
2-channel

SA3-02B

- 2x changeover contacts 8 A/AC1
- switching voltage 250 V AC1, 24 V DC
- controls shutters, lights, appliances etc.
- rated current 50 mA from BUS



Analog-digital converter

ADC3-60M

- integration of sensors with analog outputs
- 6x analog inputs
- supports voltage, current and resistance signals
- rated current 100 mA from BUS



Digital-analog converter

DAC3-04B | DAC3-04M

- generates analog voltage signal
- 4x analogue output
- controls eg. RFDA-73M/RGB
- rated current 50 mA from BUS



Binary input unit

IM3-20B, IM3-40B | IM3-80M
IM3-140B

- are used for connecting of devices with potential free contacts
- contact of device can be NO or NC
- 2x, 4x, 8x, 14x digital input
- rated current 20 mA from BUS

Use case 1:
Central unit on EACH FLOOR

Room / **299**

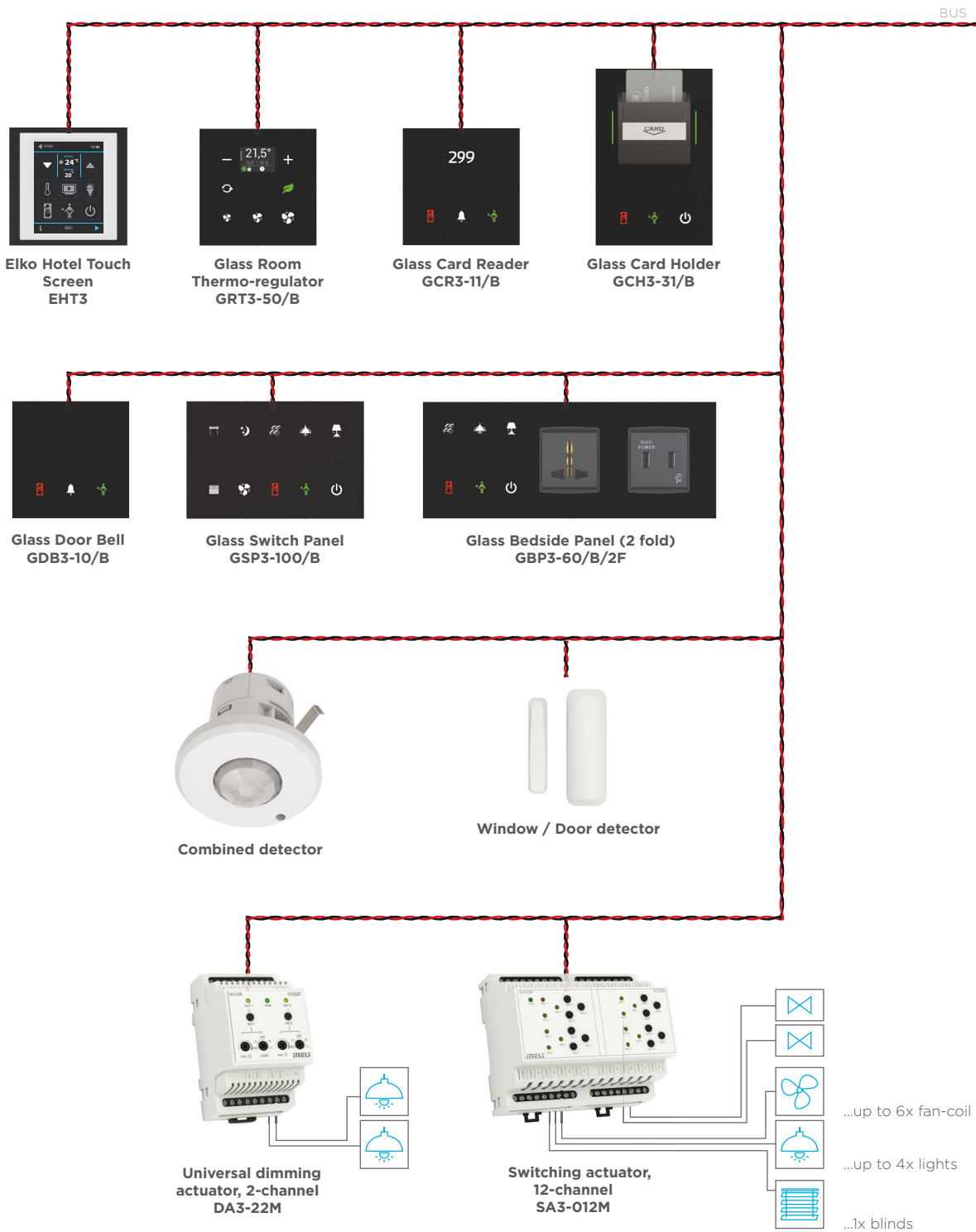

BUS/GRMS Solution

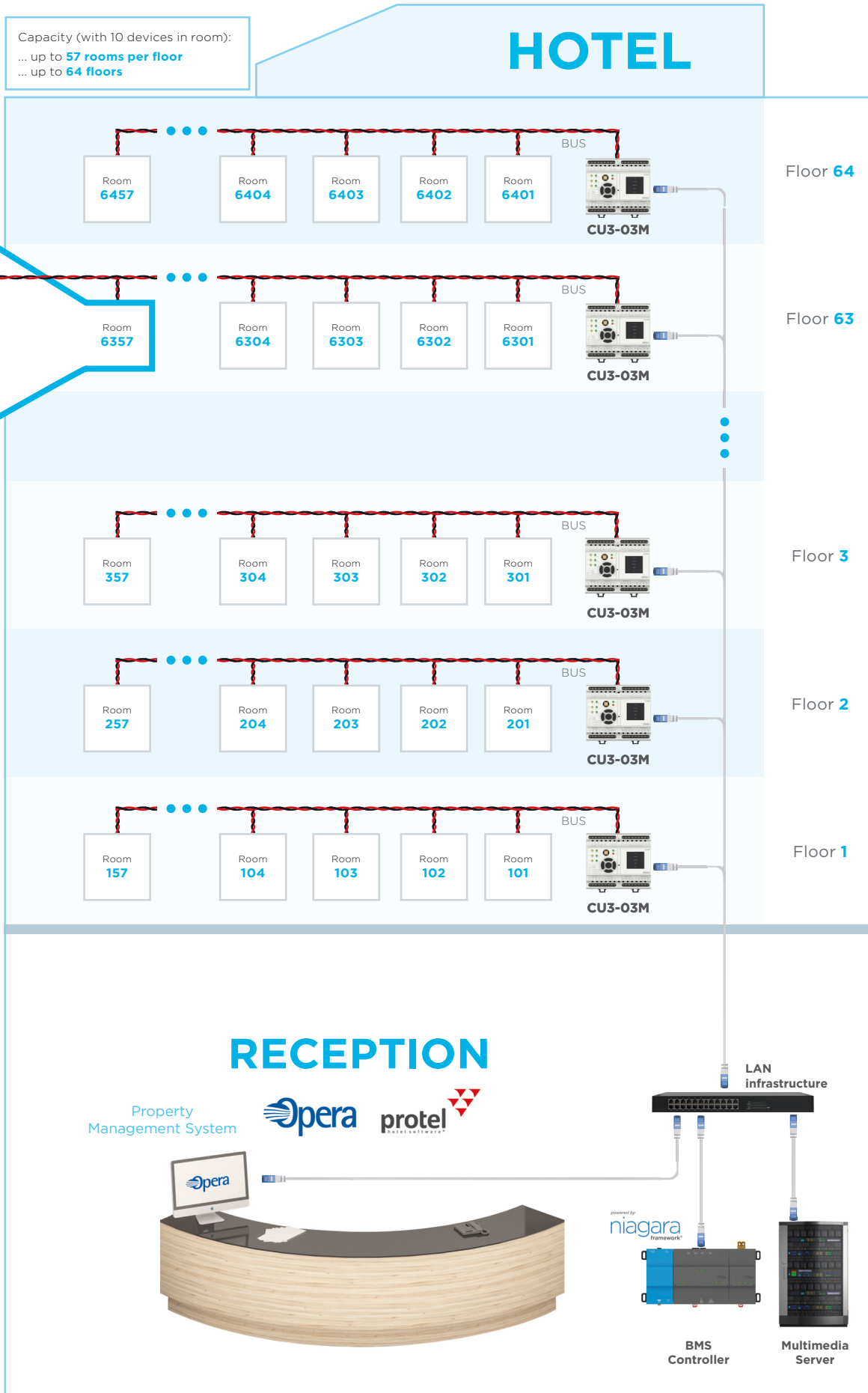

Use case 2:
Room controller on EACH ROOM

Room / **299**

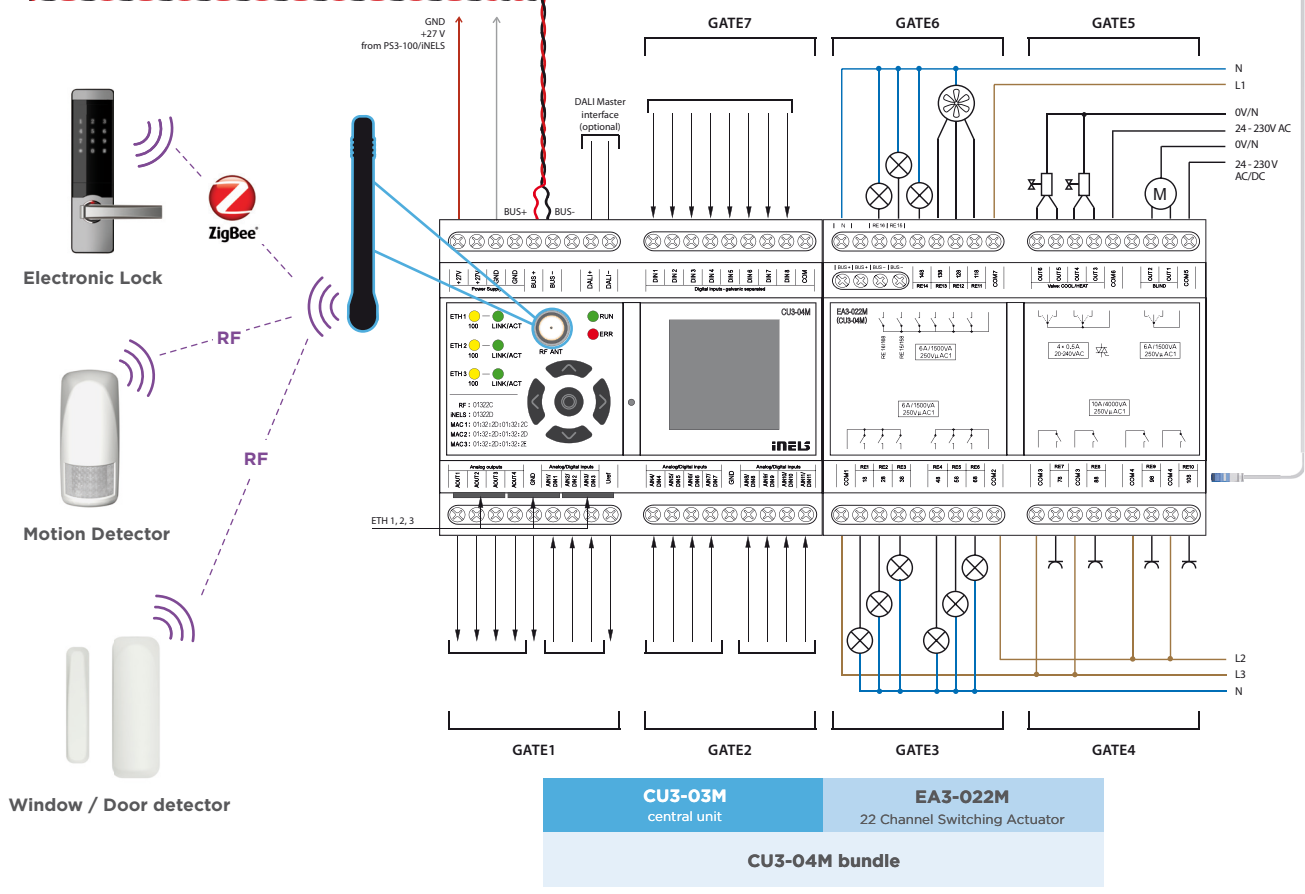
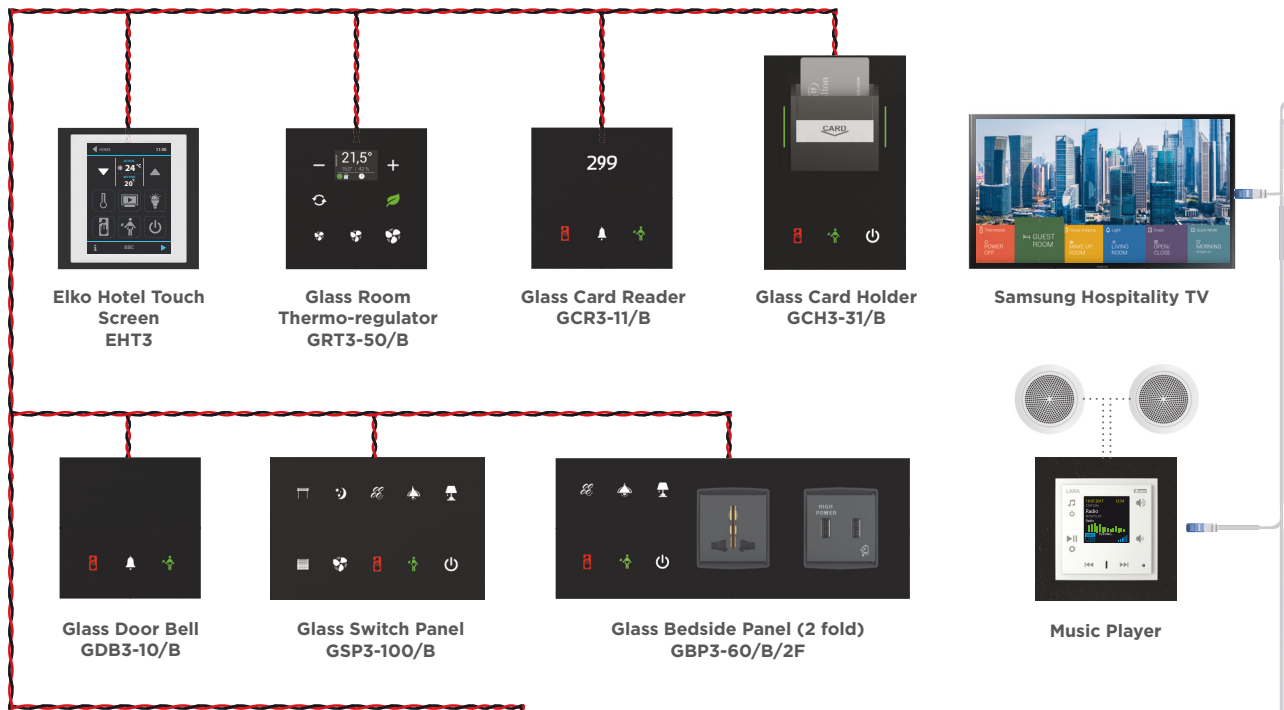

BUS/GRMS Solution

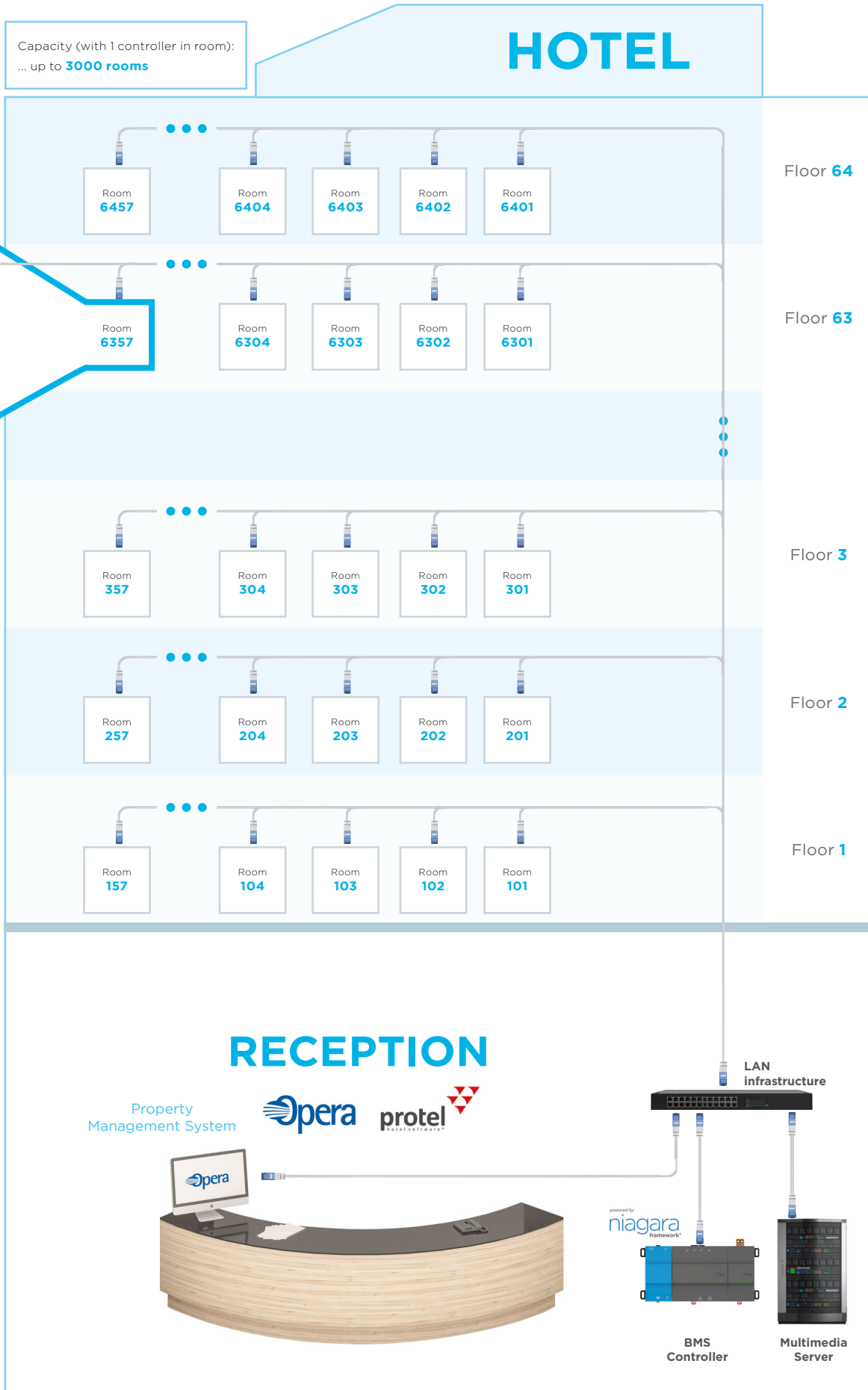

Bedside panels configuration

Socket

(Number in brackets is original Vimar product code.)

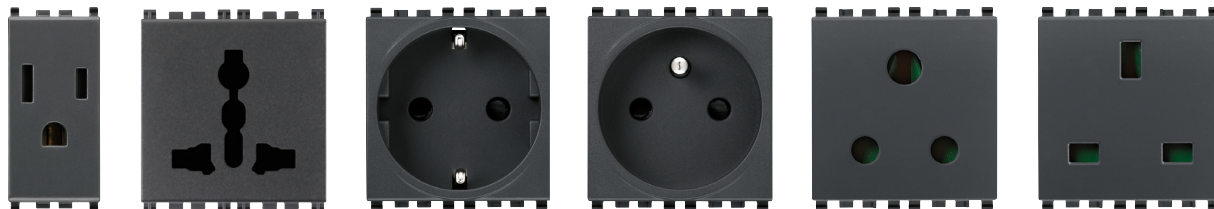

USA outlet

Multistandard outlet

Schuko outlet

French outlet

PIN outlet

British outlet

21B (20242)

26B (20257)

22B (20208)

23B (20212)

24B (20214)

25B (20219)

21W (20242.B)

26W (20257.B)

22W (20208.B)

23W (20212.B)

24W (20214.B)

25W (20219.B)

Switch

(Number in brackets is original Vimar product code.)

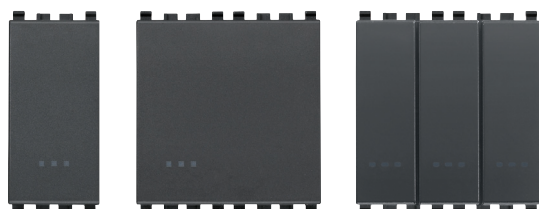

One switch / 1M

One switch / 2M

Three switches

11B (20001)

12B (20001.2)

14B (20003)

11W (20001.B)

12W (20001.2.B)

14W (20003.B)

Data & Audio/Video

(Number in brackets is original Vimar product code.)



USB power supply unit

TV-FM-SAT socket outlet

VGA connector

20B (20295)

31B (20303)

32B (20348)

20W (20295.B)

31W (20303.B)

32W (20348.B)

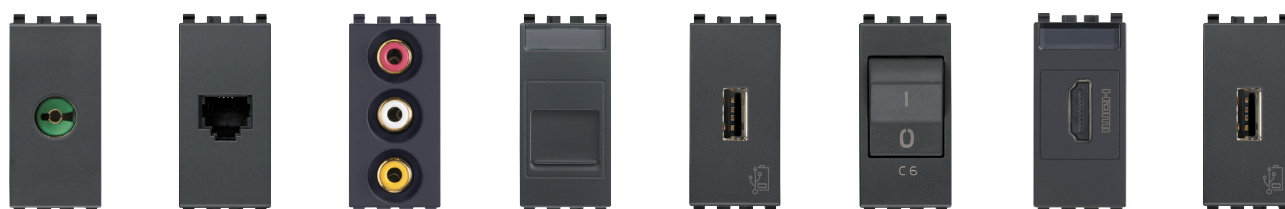

TV outlet

Phone outlet

A/V connectors

UTP outlet

USB supply unit

Switch (CBs)

HDMI connector

USB outlet

41B (20313)

42B (20320)

43B (20335)

44B (20337.6)

48B (20292)

46B (20405.06)

47B (20346.H)

45B (20345)

41W (20313.B)

42W (20320.B)

43W (20335.B)

44W (20337.6.B)

48W (20292.B)

46W (20405.06.B)

47W (20346.H.B)

45W (20345.B)

Plastic Bedside Panel

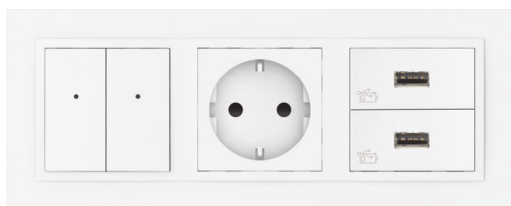

Schuko

Mechanism 21130
Cover 90632 TBR



French

Mechanism 21110
Cover 90652 TBR



EURO - USA

Mechanism 21140
Cover 90842 TBR



British

Device 90184

Glass Bedside Panel

(Configure bedside panel according to your request.)

L (left option)

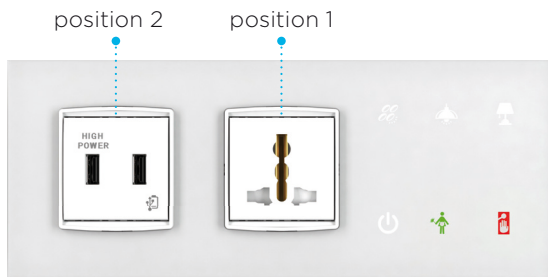

GBP3-60/WL/2F-26W-20W

R (right option)

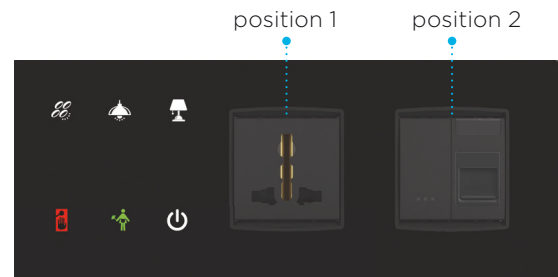

GBP3-60/BR/2F-26B-11B44B

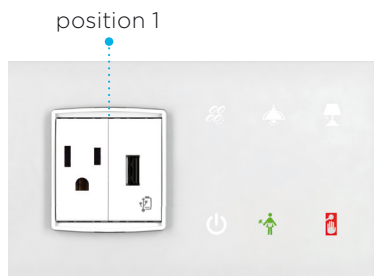

GBP3-60/WL/1F-21W45W

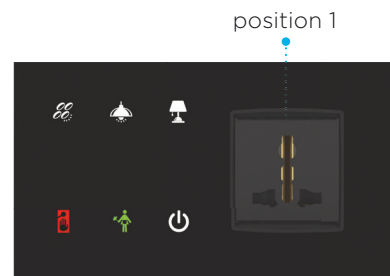

GBP3-60/BR/1F-26B

Part number

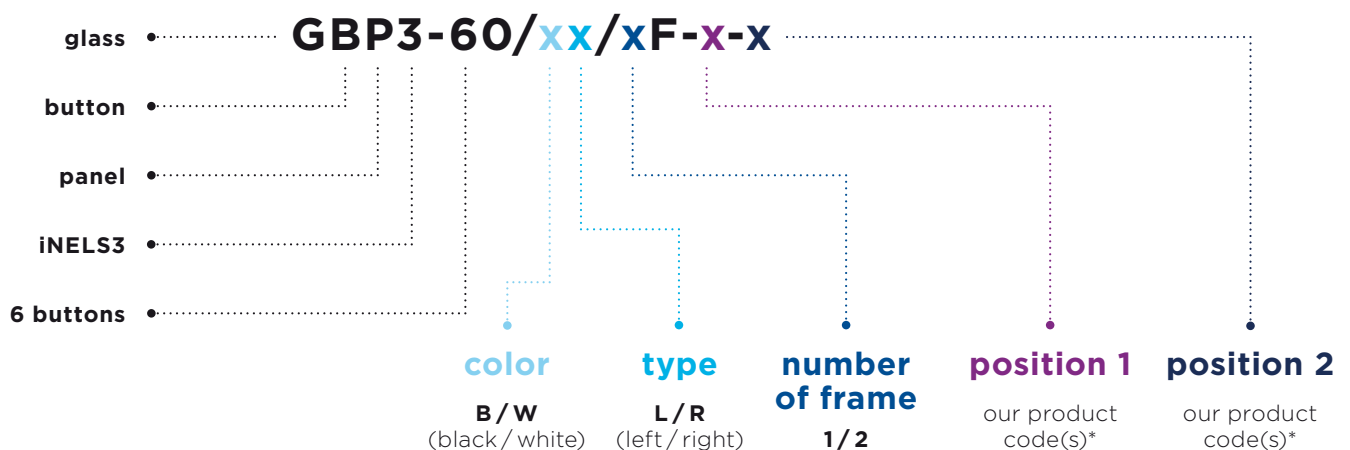

* In case of 1-module choice it is necessary to pick **2x** 1-module to fill up the 1 position, for example GBP3-60/WL-**21W45W**.

If you have any question contact our sales representative.

For more information:



https://download.vimar.com/irj/go/km/docs/z_catalogo/DOCUMENT/B_C17013Eikon_inglese.76173.pdf

Reception console

The iDM Hotel software configuration tool is used by the iNELS central units through which are controlled all the peripheral units such as wall controllers, thermostats or input unit on the one hand and output actuators on the other. iDM Hotel has been developed with the emphasis on user friendliness and ease of navigation even in large projects, commercial buildings and allows management of the system by remote access. iNELS central units are equipped with a universal protocol for communicating with superior BMS and PMS systems, and through iDM Hotel are exported all objects used in communication between BMS and iNELS.

Room control/Indication

ROOM 1 

temp.	actual	23,5°
	set	22,4°
cooling		
		

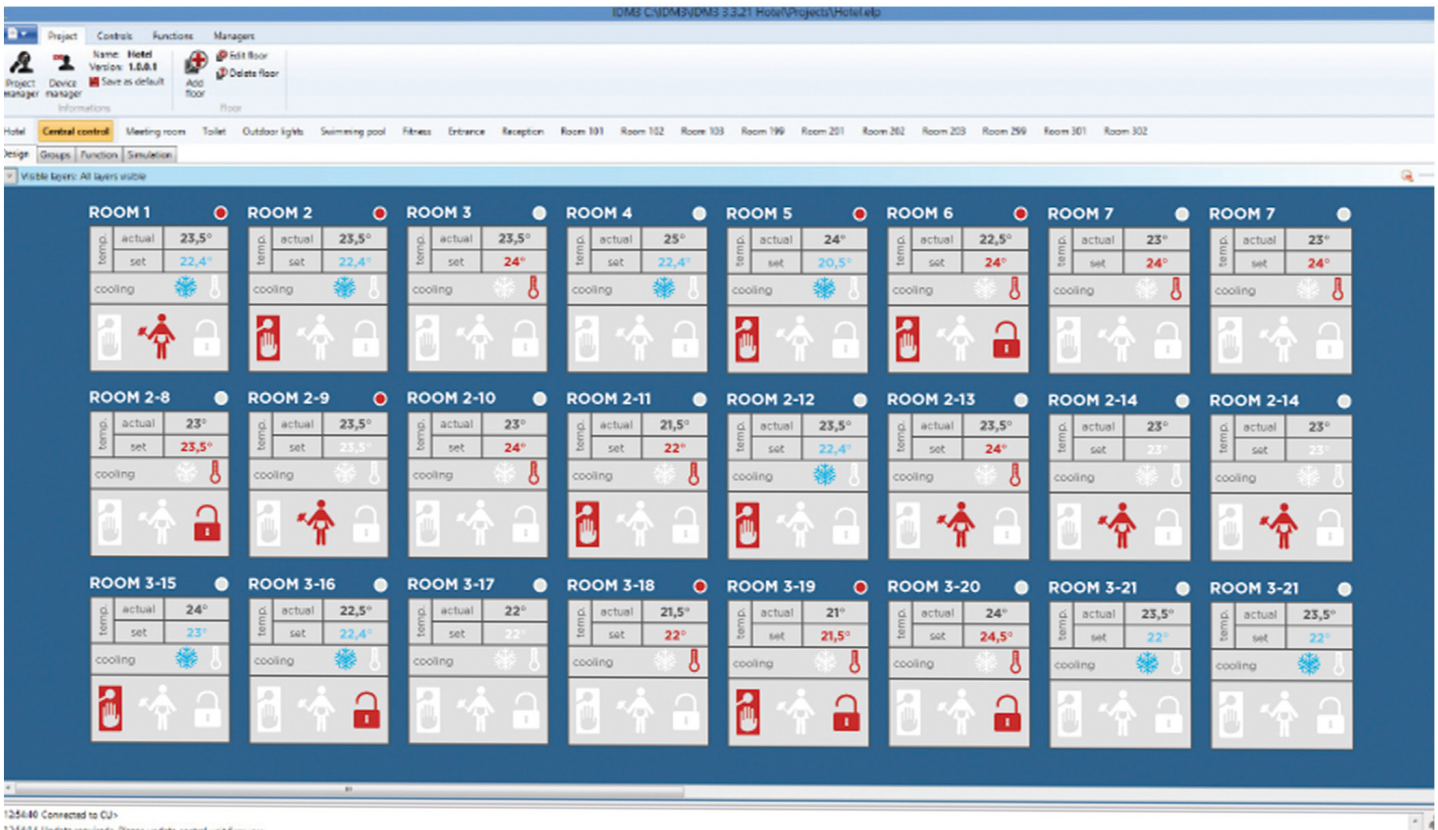
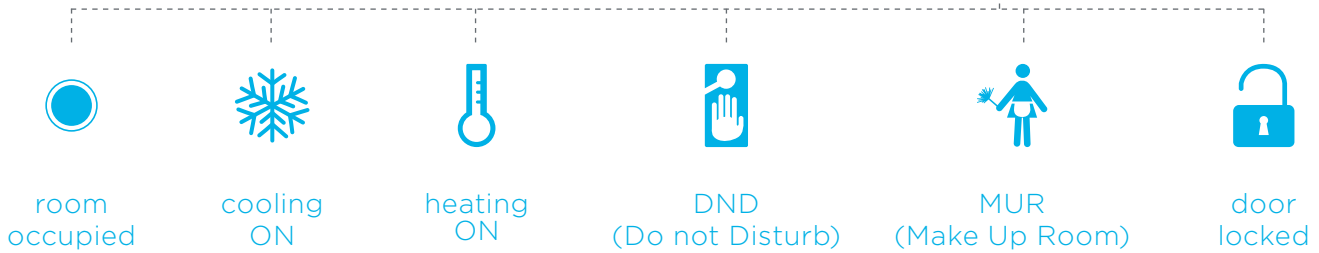

Customization

Broad selection of color variations (design LOGUS⁹⁰)

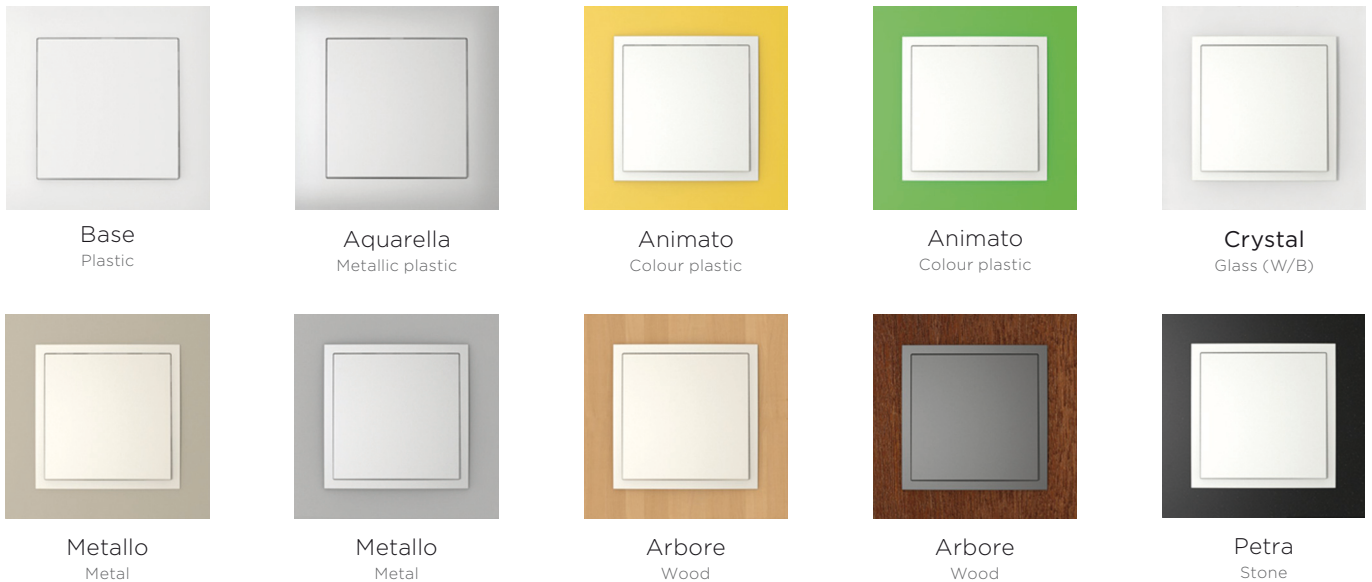

Standard symbols for laser on plastic key and glass panel

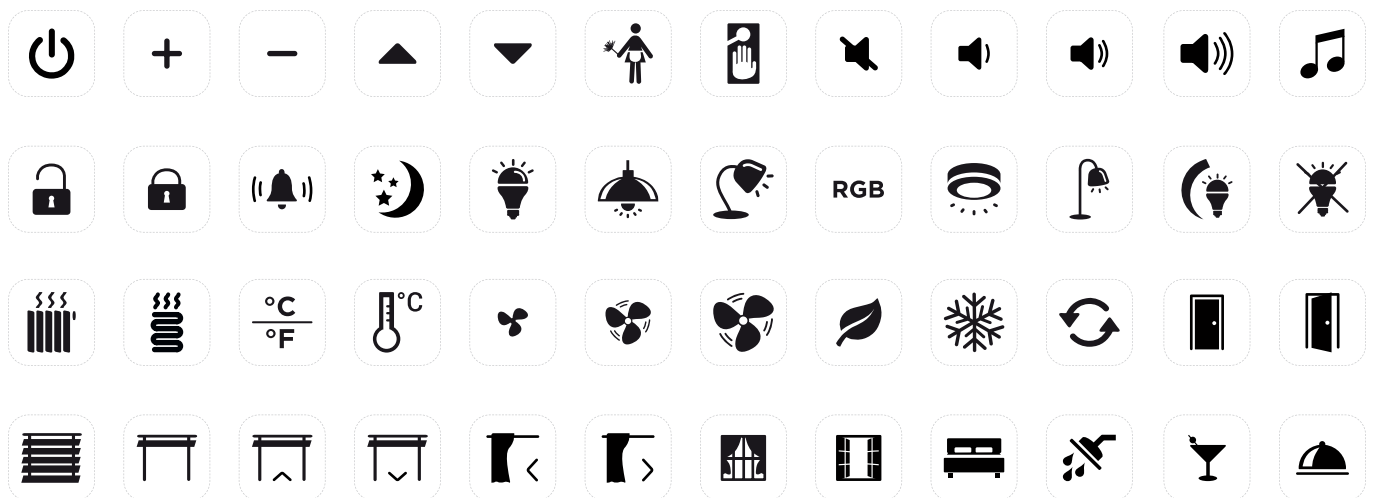

... other on request

Glass colour selection



... and other colours

Integration with BMS & PMS

BMS - Building Management System
 PMS - Property Management System

Buildings today are equipped with an array of systems to control HVAC (heating, ventilation and air conditioning), lighting, shading, security, GRMS (Guest Room Management System), energy management, emergency lighting, fire alarms, CCTV, access control systems, elevators and other technologies. Effective integration and communication among the various systems in the building is critical to creating a comfortable environment for all users, to reduce building operation costs and reduce carbon dioxide emissions required for the operation of buildings.

INELS is a great solution for a variety of jobs, particularly in the areas of lighting, shading and GRMS (Guest Room Management System), and thanks to its modular and flexible topology it is used in commercial projects of hotels, office buildings, restaurants, wellness centres or manufacturing plants and warehouses.

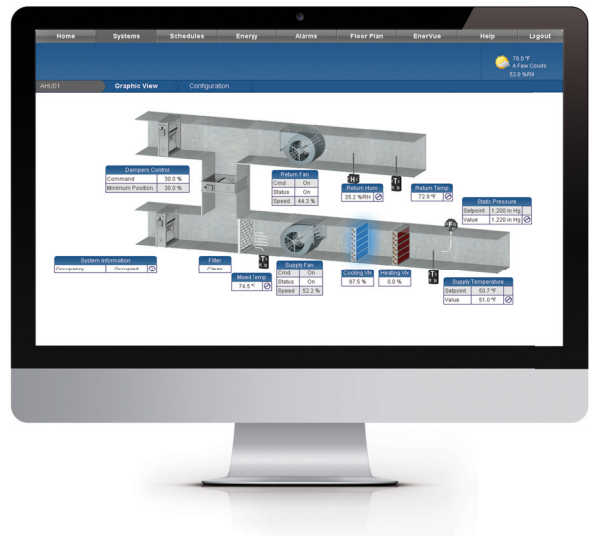

AVAILABLE PROTOCOLS: *



* A complete list can be found on www.inels.cz.



EXISTING hotel room

This is the automatic control of lighting, which is controlled by a combination of sensors (motion / door) and a switching component. Operation is fully automatically or via a wireless controller, which is beyond the basic functions (ON/OFF). Additionally MASTER OFF function (one touch turns off all the lights). Can control not only the main room lighting, but also a lamp in the corner of the room, curtains/blinds or can disable all/some of the socket circuits. This combination of detector and the switching component provides hoteliers savings in lighting costs and customer ease of use.



Motion Detector

Combination of detectors and Master switching unit bring automatic lighting control.



Window / Door Detectors

Combination of door/window open detectors and Master switch unit bring automatic thermoregulation.



Wireless Dimmable LED

Dimming is one of the basic characteristics of a smart home. Dimmers not only render a pleasant atmosphere, but also save on electricity. iNELS offers dimmers in various designs (box, flush, DIN rail mounted, socket) for all types of light sources including today's popular LEDs.



Wireless temperature controller

Combination of digital thermoregulator RFTC-150/G and switching unit RFSA-166M is used for fan coil temperature control in the room. Regulator can change the standard temperature modes of heat and cool and it has three stages speed mode - low, medium, high.

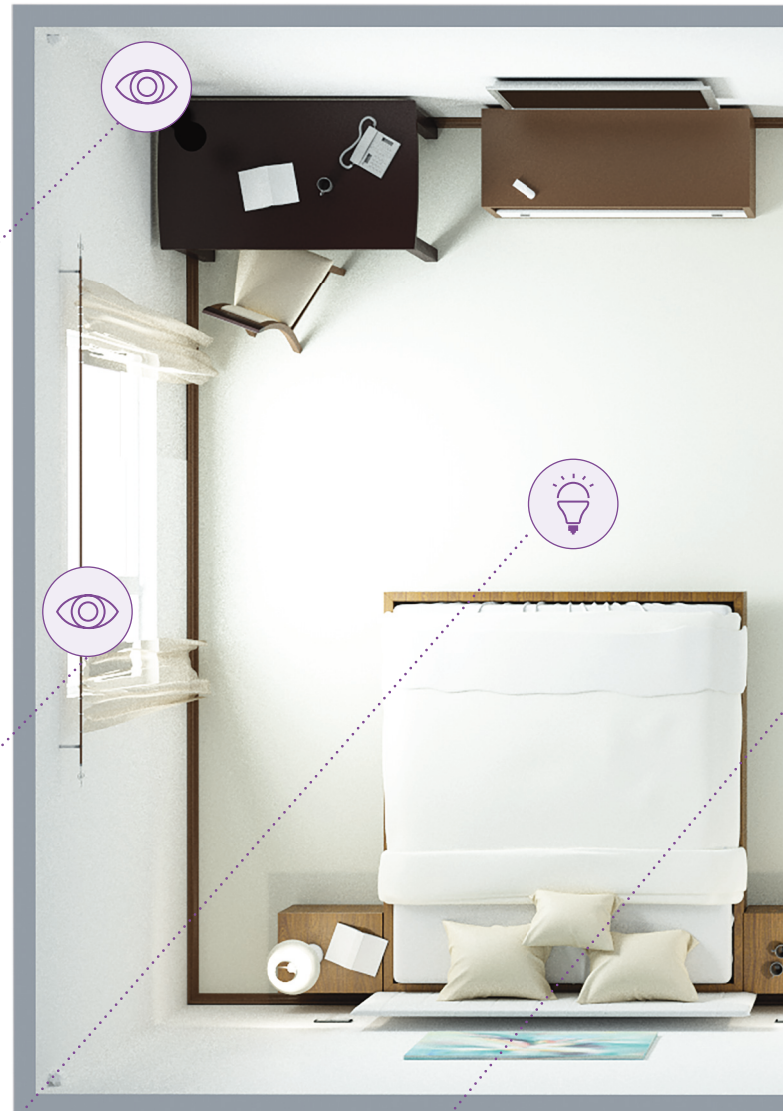

WIRELESS RETROFIT

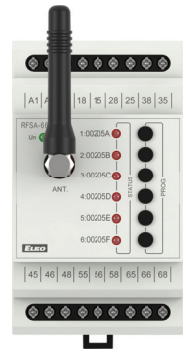

Wireless switch unit

Wireless actuator for fan-coils control. It can switch motor speed in three speeds and heating/cooling mode. DIN rail box for panel mounting, cooperation with RFTC-150/G thermoregulator.

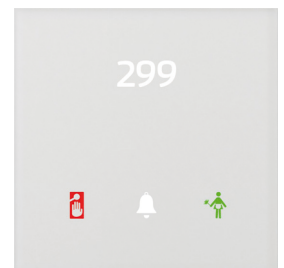

Glass switch button with symbols

Wireless bell button for a flexible placing to any place in front of a room door. Call for buzzer or piezo inside of RFSa-166M unit (if used).



Wireless Wall Controller

Thanks to the flat base of wireless switch is easy to put it on the nightstand, wall or glass wall. Wireless switch has a function MASTER OFF. When the button is pressed it will turn off all the lights and a fan in the room, curtains close.



Radio & Music Player

LARA is a choice if you want to listen to music in a room. LARA is an internet radio, player of your favorite music from your smartphone or hotel central storage of music.



Glass Card Holder

After inserting a hotel card to card switches it will activate automatic regulation of lights in the room. If guest is leaving the room and closing the door where is installed door detector RFDW-100 then it sends a command „delay OFF“ and the light turns off.

Product overview

Controllers

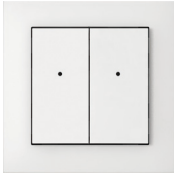

Wireless wall controller
RFWB-20/G, RFWB-40/G

- power: 3 V CR 2032 battery
- 2 channels/4 channels
- scenes function
- command LED indication
- switching with a micro-button



Door Bell
RFWB-20/G

- power: 3 V CR 2032 battery
- 2 channels
- command LED indication
- switching with a micro-button



Wireless touch unit
RF Touch

- power: 100–230 V AC, from the side 12 V DC
- setting with up to 40 units + 30 detectors
- central unit with autocontrol
- coloured TFT LCD display, 3.5"
- wall (surface), Flush



Wireless remote controller with display

RF Pilot

- power: 2x 1,5 V AAA batteries
- setting with up to 40 units
- inbuilt temperature sensor
- scene function
- status visualization
- colour OLED display

Switches & Dimmers

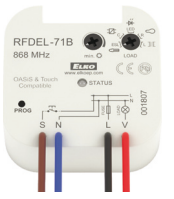

Universal Dimmer
RFDEL-71B

- type of load: R, L, C, LED, ESL
- control from external button
- light scenes function
- minimum brightness setting
- overheat protection
- operated from 32 channels



Wireless switch unit with the input

RFSAI-161B

- load: 16 A
- special function for master off and unblock with PIR and door detectors
- operated from 32 channels (of controllers)
- terminal for control from existing button

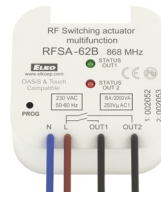

Wireless switch unit
RFSA-62B

- load: 16 A
- time-functions (2 s.—60 min.)
- operated from 32 channels (of controllers)
- terminal for control from existing button



Wireless switch unit
RFSA-66M

- power: 110–230 V AC/50–60 Hz
- load: 6x 8 A
- 6 independent channels
- time-functions (2 s.—60 min.)
- operated from 32 channels (of controllers)
- option of connecting an external antenna

Audio Distribution

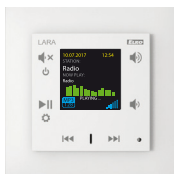

Audio Player
LARA

- plays the stream of internet radios and music from NAS or external source
- equipped with a digital internal amplifier 2x10 W
- power over Ethernet, design LOGUS⁹⁰

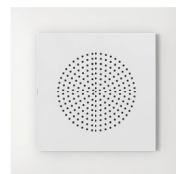

LOGUS Speaker
Into a frame

- dimensions (mm): \varnothing 50.8
- maximum output: 10 W
- impedance: 32 Ω
- design LOGUS⁹⁰



Ceiling Speaker
Into a suspended ceiling

- dimensions (mm): \varnothing 127
- maximum output: 30 W
- impedance: 8 Ω
- colour: white

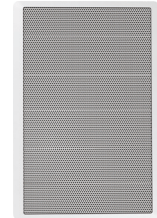

Wall Speaker
On the wall

- dimensions (mm): 270 x 183 x 37
- maximum output: 15 W
- impedance: 8 Ω
- colour: white

WIRELESS RETROFIT

HVAC Units



Smart Wi-Fi RF Box

eLAN-RF-Wi-003

- power: 10–27 V DC/200 mA SELV
- setting with up to 40 units
- LAN or Wi-Fi connection
- managing accounts/ backup of projects via web interface
- routing/repeater function
- iOS and ANDROID compatibility



Overheating protection

RFSTI-111B

- over and under temperature control
- in combination with door and window detectors
- temperature range: 15 to 35°C
- load: 16 A
- ext. input for temp. sensor



Wireless switch unit

RFSA-166M

- motor control in 3 speeds
- heating/cooling mode switch
- master on/off in combination with door/window detectors
- power: 110–230 V AC/50–60 Hz
- load: 6x 8 A
- option of connecting an external antenna



Temperature Control

RFTC-150/G

- heating/cooling mode switch
- in build preset combination with RFSA-166M
- power: 2x 1,5 V AAA battery
- temperature range: 0 to +55°C
- weekly programming
- integrated sensor
- design LOGUS⁹⁰ (glass, metal, wood, stone)

Access Control



Multifunctional in front of Controller

RFPCR-31/G
Logus⁹⁰

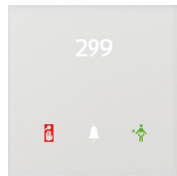

RFGCR-31/W
glass/white

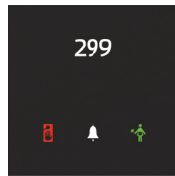

RFGCR-31/B
glass/black

- Multifunctional in front of controller included: RFID card reader, bell button, "Do Not Disturb" and "Make Up Room" signalling
- Available in LOGUS⁹⁰ colors and frames design
- Available in glass black & white colour as well
- power supply: AC 230 V
- communication: wireless 868 MHz (iNELS RF)



Card Switch

21031 & 90731
Logus⁹⁰

- A standard card switch should be connected in to the RFPCR-31/G
- Available in LOGUS⁹⁰

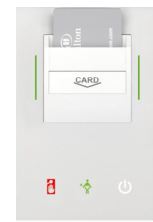

Glass Card Holder

RFGCH-31/W
glass/white

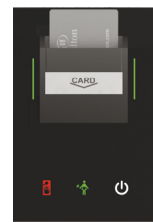

RFGCH-31/B
glass/black

- Card holder with RFID reader
- allows detect fake card
- "Do Not Disturb", "Make Up Room" signalling "Master OFF" button
- glass black & white colour
- power supply: AC 230 V
- communication: wireless 868 MHz

Detectors



Smoke Detector

RFSD-100

- power: 4x 1,5 V AA battery
- smoke detection: optical light scattering
- autotest



Motion Detector

RFMD-100

- power: 2x 1,5 V AA battery
- detection angle 105°
- shot length 12 m (13.12 yd)



Window/Door Detector

RFWD-100

- power: 1x 3 V CR2032 battery
- opened window/door detection
- battery status indication



Wireless LED Bulb

RF-RGB-LED-550

- power: 100–240 V AC 50/60 Hz
- luminous flux: 550 lm / 675 lm
- brightness regulation: 0–100%
- compatible base: E27
- durability: 30 000 h.

Use case 1: SIMPLE RETROFIT

Combination of existing switch with wireless controllers

- control local HVAC system with 1 speed fan-coil

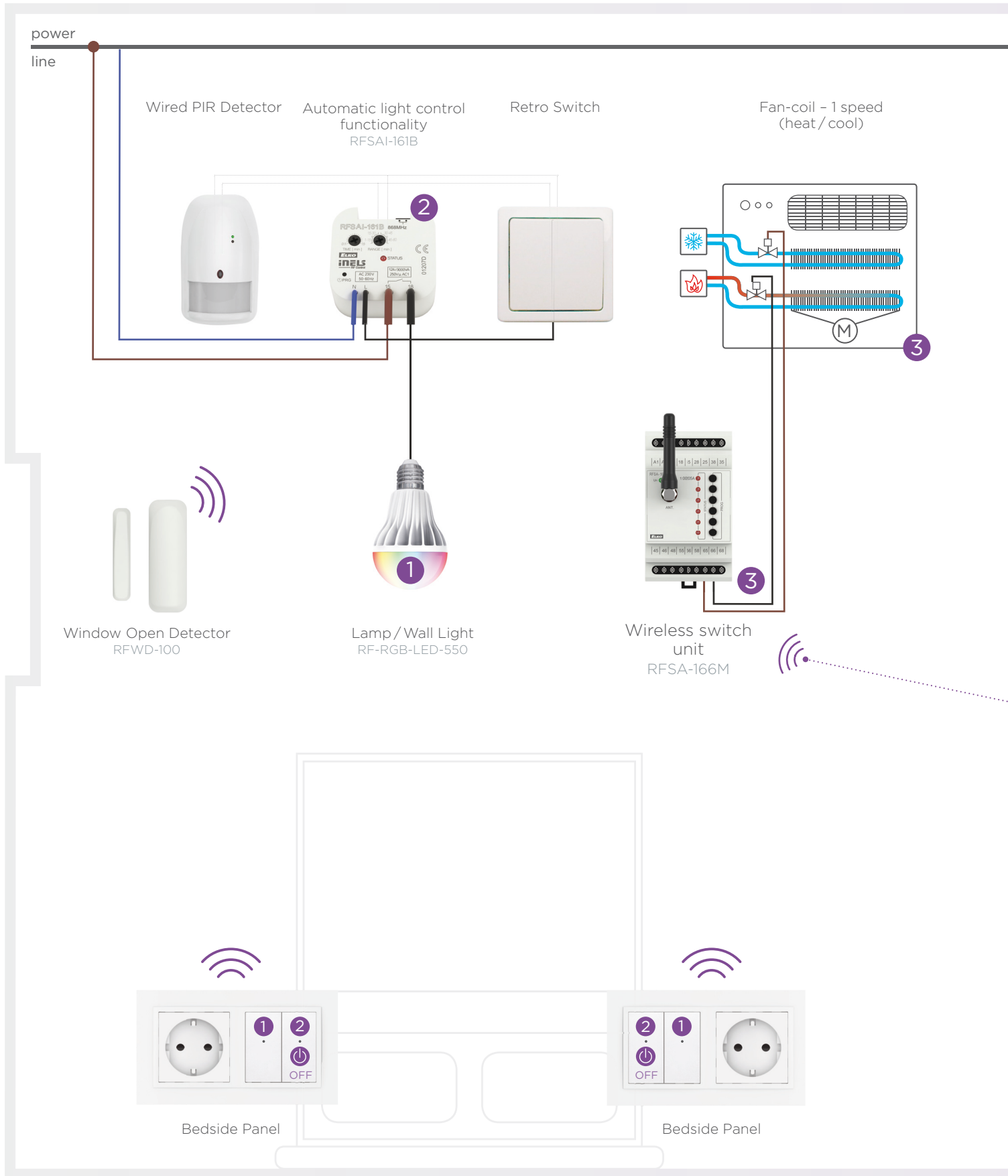

WIRELESS RETROFIT

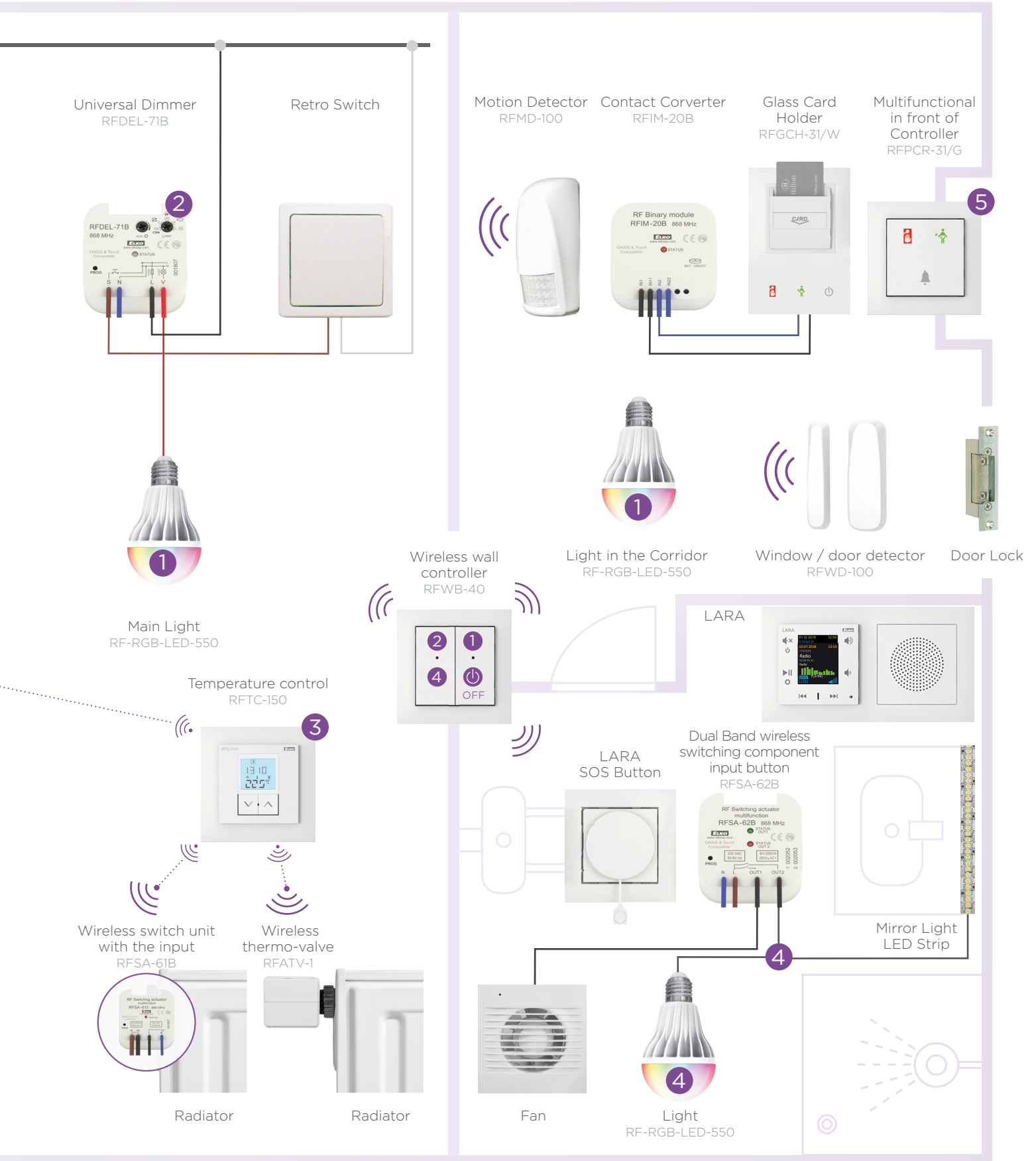

Use case 2: FULL RETROFIT
All devices are fully wireless

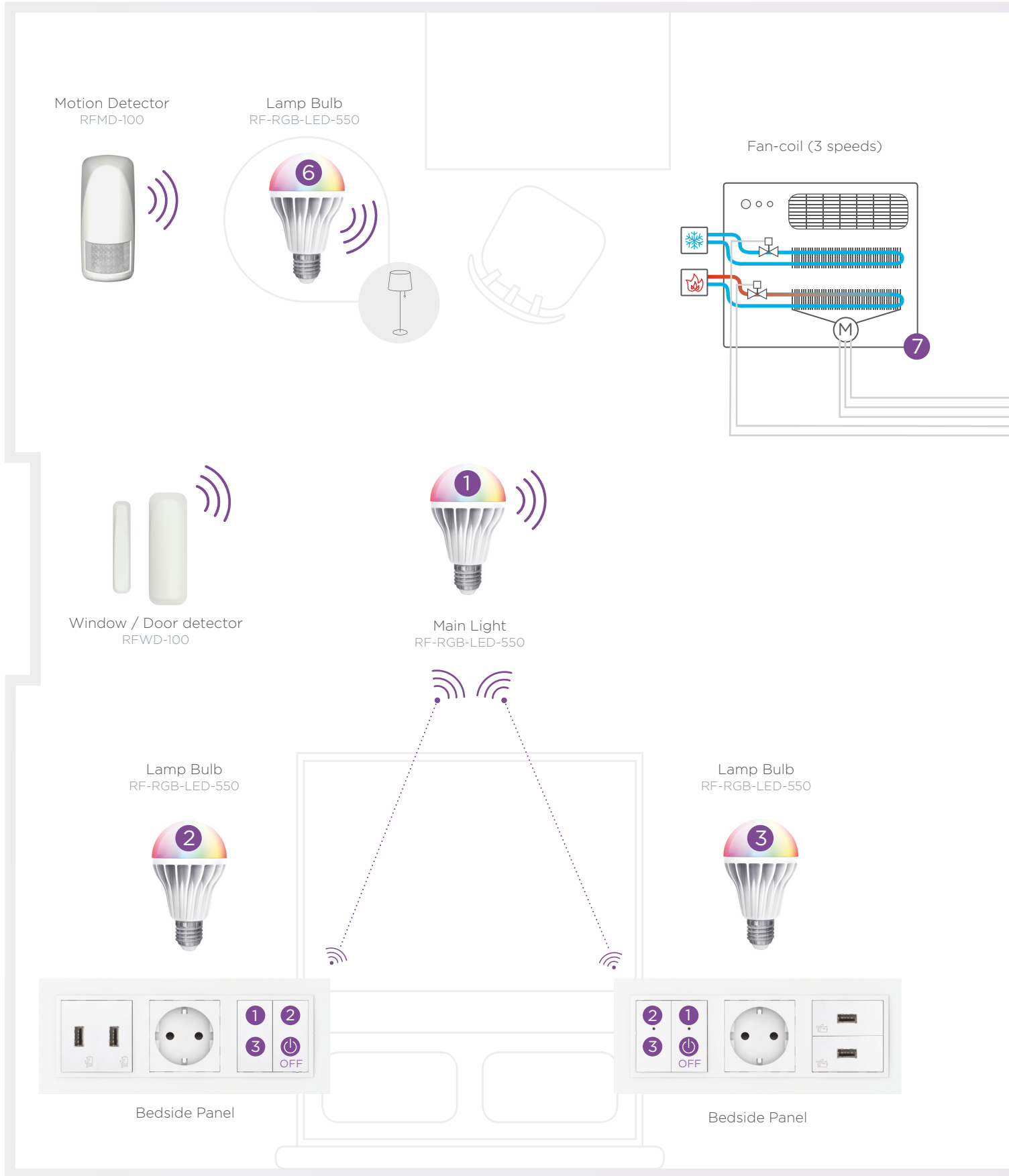

WIRELESS RETROFIT

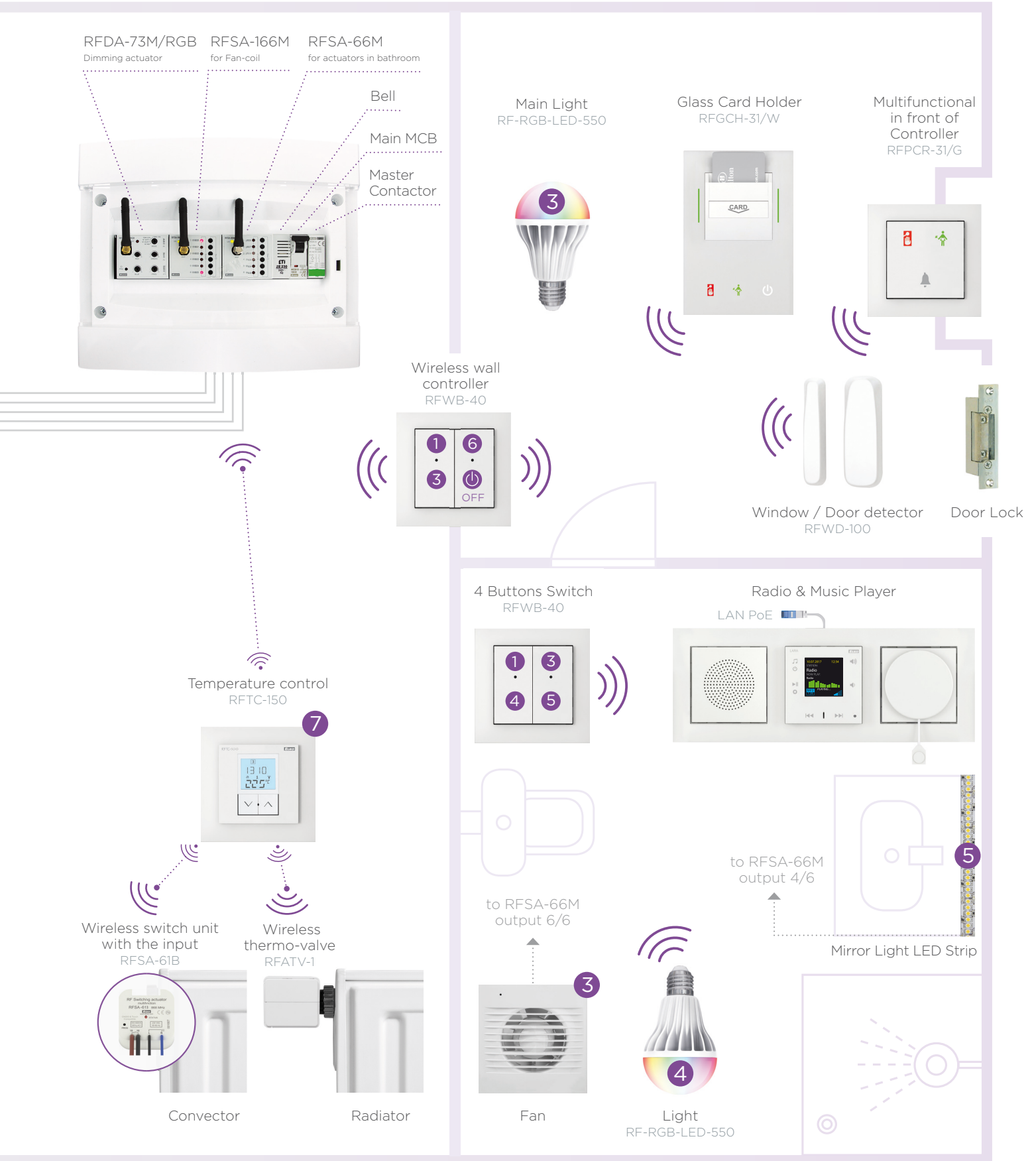

Product dimensions

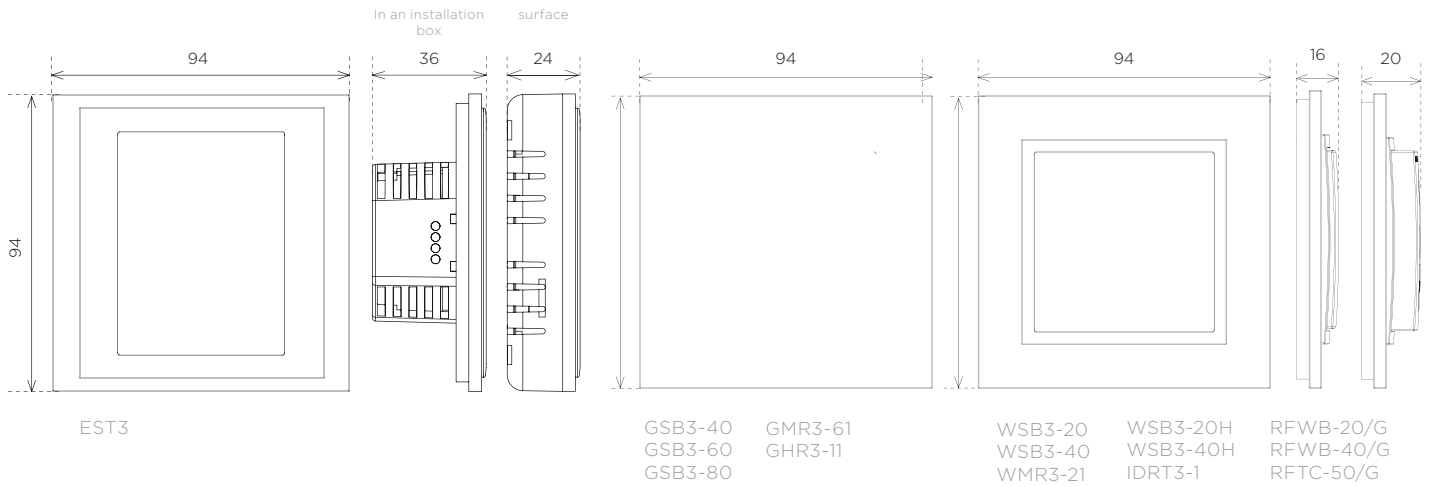

6 Module

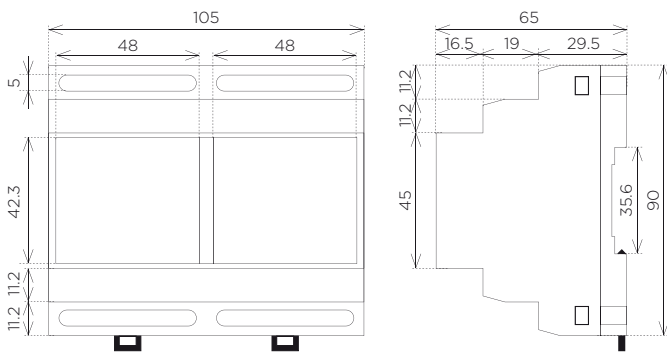

CU3-01M PS3-100/iNELS DA3-06M
 CU3-02M SA3-012M JA3-09M
 CU3-03M SA3-022M

3 Module

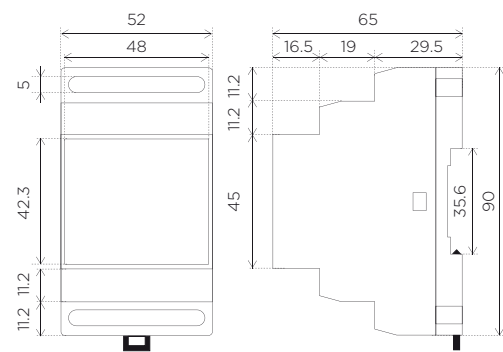

EMDC-64M LBC3-02M ADC3-60M
 GSM3-01M DCDA-33M DAC3-04M
 SA3-04M RFDA-73M RFSA-66M
 SA3-06M IM3-140M RFDEL-71M
 DA3-22M TI3-60M RFDA-73M/RGB
 RFPM-2

1 Module

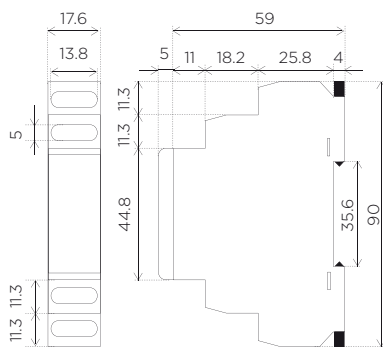

MI3-02M BPS3-02M
 SA3-02M RFSA-61M
 BPS3-01M

MINI

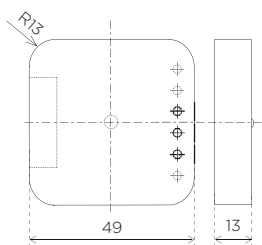

JA3-02B/DC TI3-10B
 IM3-20B TI3-40B
 IM3-40B RFTI-10B
 IM3-80B RFSF-1B
 DAC3-04B

MINI

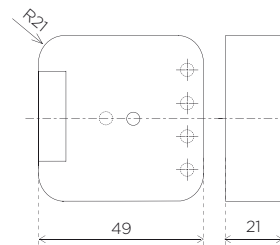

SA3-01B RFSA-62B
 SA3-02B RFSAI-61B
 RFDEL-71B RFJA-12B/230V

Installation possibilities

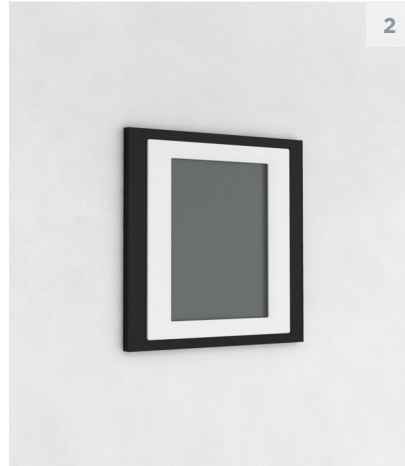

1) Surface mounted

Wall mounted or in an installation box with spacing of 65 mm.

RFSD-100	RFMD-100
RFWB-20/G	RFTC-50/G
RFWB-40/G	RF Touch

2) Flush mounted

RF Touch-B	EST3	WSB3-20
RFSTI-11/G	GSB3-40	WSB3-40
RFTC-100/G	GSB3-60	WSB3-20H
RFDW-71	GSB3-80	WSB3-40H
	GMR3-61	IDRT3-1
	GHR3-11	
	WMR3-21	

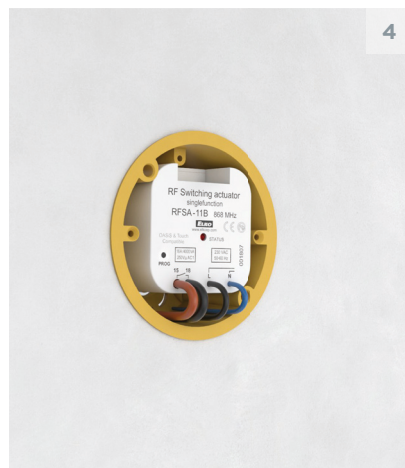
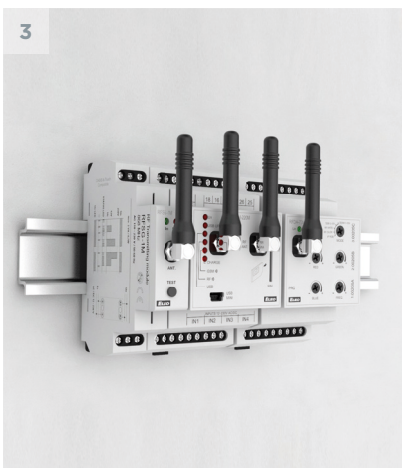

3) DIN Rail mounted

On DIN rail according to EN 60715.

RFSG-1M	ADC3-60M	IM3-140M
RFGSM-220M	BPS3-01M	JA3-09M
RFPM-2M	BPS3-02M	LBC3-02M
RFDA-73M/RGB	CU3-01M	MI3-02M
RFDEL-71M	CU3-02M	PS3-100/iNELS
RFSA-61M	CU3-03M	SA3-02M
RFSA-66M	DA3-06M	SA3-04M
RFSA-166M	DA3-22M	SA3-06M
	DAC3-04M	SA3-012M
	DCDA-33M	SA3-022M
	EMDC-64M	TI3-60M
	GSM3-01M	

4) Mounted to or in the installation box

RFIM-20B	RFJA-12B	DAC3-04B
RFIM-40B	RFJA-32B	IM3-20B
RFDAC-71B	RFJF-1B	IM3-40B
RFDEL-71B	RFSTI-11B	IM3-80B
RFSA-11B	RFTI-10B	JA3-02B/DC
RFSA-61B	RFSAI-161B	SA3-01B
RFSA-62B	RFSTI-111B	SA3-02B
RFSAI-61B		TI3-10B
		TI3-40B

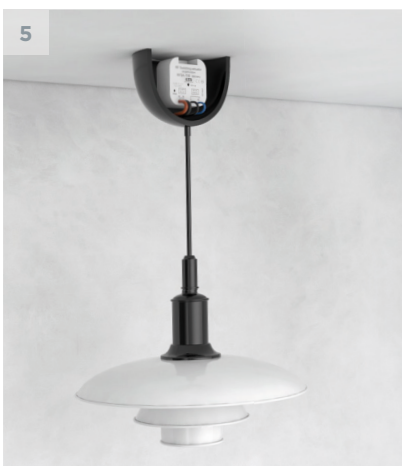

5) Mounted into the cover of appliance

RFDAC-71B	RFSAI-61B
RFDEL-71B	RFJA-12B
RFSA-11B	RFJA-32B
RFSA-61B	RFSAI-161B
RFSA-62B	RFSTI-111B

6) Surface mounted

RFSOU-1	RFSD-100
RFUS-61	RFMD-100
RFTM-1	RFWD-100
RFJF-1B	

ELKO EP



We are traditional, innovative and purely Czech development manufacturer of electronic devices and we have been your partner in the field of electroinstallations for 26 years.

ELKO EP employs about 330 people, exports its products to more than seventy countries, and has representatives in thirteen foreign branches. Company of the Year of the Zlín Region, Visionary of the Year, Global Exporter of the Year, Participation in the Czech TOP 100, these are just some of the awards received. Still, we are not finished. We are constantly striving to move forward in the field of innovation and development. That's our primary concern.

Millions of relays, thousands of satisfied customers, hundreds of our own employees, twenty six years of research, development and production, thirteen foreign branches, one company. ELKO EP, innovative- a purely Czech company based in Holešov, where development, production, logistics, service and support go hand in hand. We primarily focus on developing and manufacturing systems for building automation in the residential, commercial and industrial sector, a wide range of Smart city facilities and the so-called Internet of Things (IoT).



Facts and stats

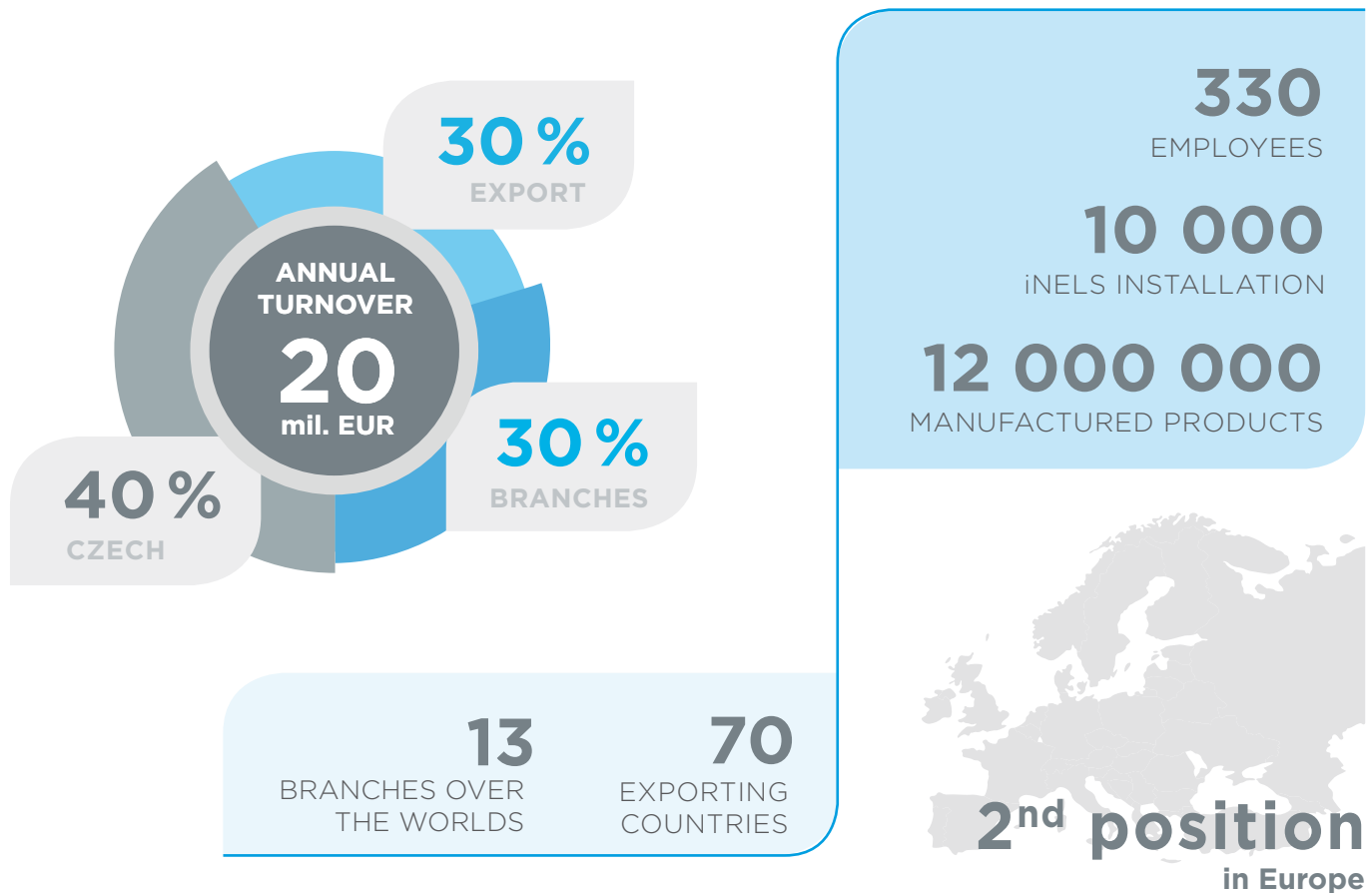

WE ARE



DEVELOPERS

In the new R&D center, more than 30 engineers develop new products and extend the functionality of existing products

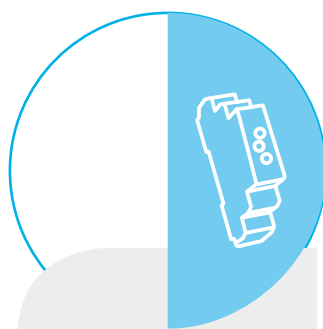

PRODUCERS

modern antistatic spaces, 2x fully automated SMD production lines, 2 shift operations.



SUPPORT

24 hours / 7 days / 360 days we not only provide technical support but also logistics.



SELLERS

personal access to more than 70 sales representatives in ELKO EP Holding provides impeccable services and superior products at an affordable price.

References



Kempinski Hotel Bayterek

Almaty / Kazakhstan

- 5-star hotel in Almaty Kazakhstan
- lighting control in public areas
- more than 15 000 lighting are control through the DALI protocol
- setup scenes



Marriot Marquis

Doha / Qatar

- 5-star hotel in the Doha City center
- 44 floors, 397 rooms, 182 suites, 18 meeting rooms
- lighting control
- HVAC control
- master switch OFF

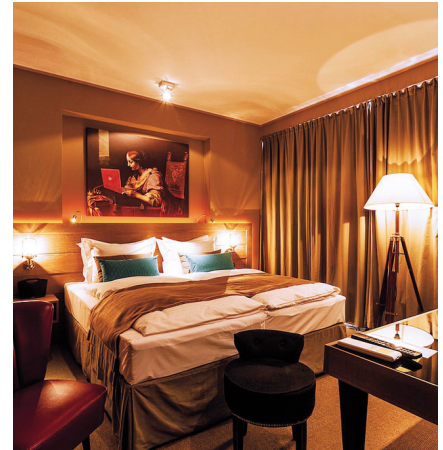

Baltazár Boutique

Budapest / Hungary

- access card control
- lighting scenes in the restaurant
- supervision from BMS
- app available for any guest



Movenpick

Dubai / UAE

- 255 rooms, 230000 sq, 530 units, 1600 light circuits
- control appliances, lights
- HVAC control
- garage doors, sockets



Wyndham Grand

Istanbul / Turkey

- lighting control in each room, the common areas, conference rooms and other spaces
- 3000 lighting circuits are controlled through the DALI protocol
- EMDC units

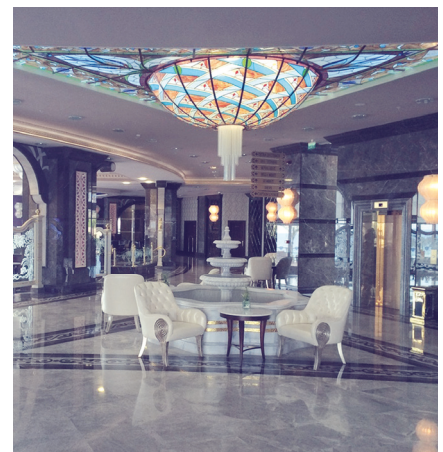

Merit Royal Premium

Kyrenia / Cyprus

- 125 rooms
- complete management of hotel rooms
- scenes: arrival / departure and day / night
- Guest Room Management System

References



Meydan

Dubai / UAE

- lighting control
- crystal chandelier
- starry night sky control
- audio/video system



Cal Reiet Santanyi

Mallorca / Spain

- swimming pool technology control
- fountain control
- Guest Room Hotel Management System



Farm Motel

Poříčí / Czech Republic

- lights scenes
- heating control
- blinds



Best Western Premier

Brno / Czech Republic

- 4-star Hotel Internacional in Brno
- lighting scenes in the restaurant, reception, wine shop and exterior
- app available for any guest



Three sons and daughter

Skhidnycya / Ukraine

- 5-star hotel
- 179 fully automated rooms powered on iNELS
- automation of lighting, heating, cardreaders
- in every room there is SA3-012M, IM-140M, WSB3-40



Living Showroom

Prague / Czech Republic

- designed residential showroom about 36 m²
- control units are part of the interior
- stage connection with projection and visitor needs

References



Pest-Buda Bistro & Hotel
Budapest / Hungary

- 10 rooms with unique luxury equipment with unique copper lamps and unique heating & air-condition



Alexandrovskiy
Odessa / Ukraine

- 25 rooms with fully automation and dispatching
- integration with Samsung central conditioning



Building XENEX
Žilina / Slovakia

- lighting control
- heating control, HVAC
- access control system, cameras, alarm



Lord's Palace
Kyrenia / Cyprus

- 5-star hotel
- lightig control in the restaurant, conference hall, parking, wellness and corridors



Rocks Hotel & Casino
Kyrenia / Cyprus

- 5-star hotel
- located close to historical city Kyrenia
- The lights are controlled in iNELS system via light panel, USB socket, glass thermostats



Brochure

Selection of References



- elkoep.com/download/references

More on:

www.inels.com

Others just resell

HOWEVER, WE DEVELOP AND MANUFACTURE PRODUCTS OURSELVES!

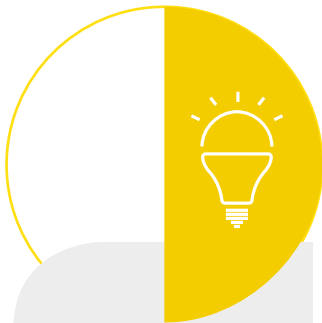

26 years
on the market



15 years
ISO certification

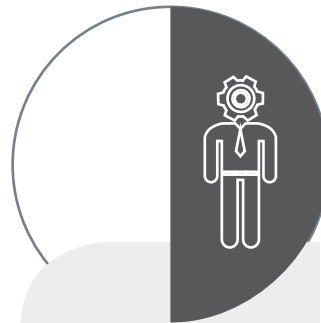

40
developers



330
employees



2 000 m²
manufacturing
space

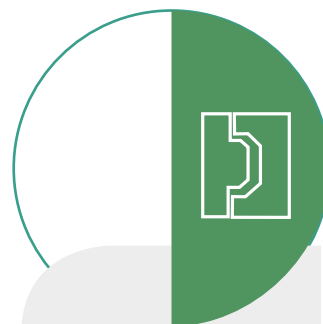

200
proprietary plastic
mods

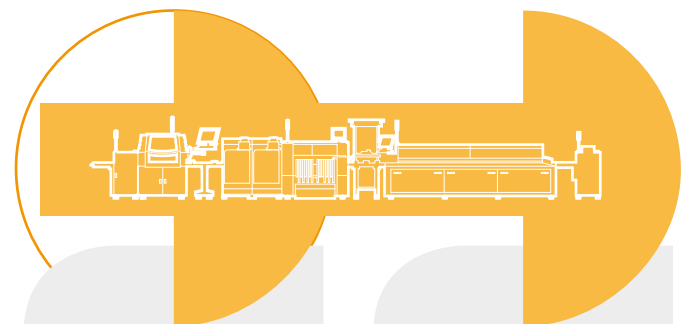

2
SMD lines

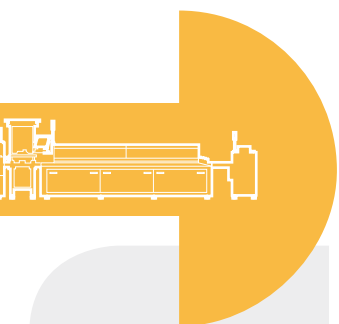

1 mil.
components
per day

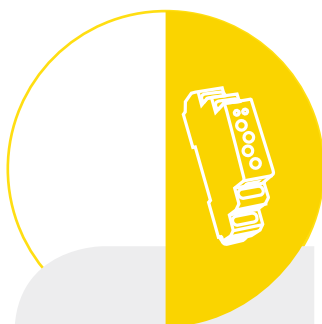

600 000
products
per year

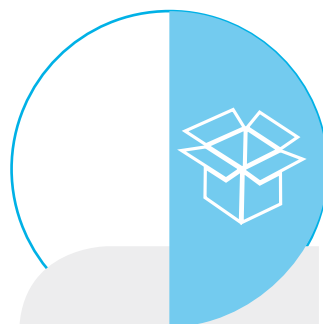

2000m²
finalization
and dispatch



2000
warehousing
spaces



2
printing lasers

ELKO EP Holding



www.elkoep.com

Published: 01/2019 | 1st edition
Modifications or amendments reserved.